

## Space Flight Operations Contract

---

# Navigation Aids Workbook NAVAIDS 21002

Mission Operations Directorate

6/30/2006

Final Version

This document has been reviewed and updated.  
No subsequent updates to this document are anticipated or  
required due to the approaching shuttle program closure.

Contract NAS9-20000

*Copyright © 2004 by United Space Alliance, LLC. These materials are sponsored by the National Aeronautics and Space Administration under Contract NAS9-20000. The U.S. Government retains a paid-up, nonexclusive, irrevocable worldwide license in such materials to reproduce, prepare derivative works, distribute copies to the public, and to perform publicly and display publicly, by or on behalf of the U.S. Government. All other rights are reserved by the copyright owner*



**Navigation Aids Workbook**  
**NAVAIDS 21002**

Prepared by

---

Kelsey Berumen, Book Manager  
USA/DPS/Nav

Approved by

---

Walter Barnett, Manager  
USA/DPS/Nav

### REVISION LOG

| <b>Rev. letter</b> | <b>Change no.</b> | <b>Description</b>   | <b>Date</b> |
|--------------------|-------------------|--|-------------|
| Basic              |                   | Update to OI-29 and MEDS. Supersedes document number TD101                                 | 12/08/2003  |
| A                  |                   | Updates for OI-30. Corrected minor grammar and formatting errors. DCR #162.                | 09/07/2004  |
| B                  |                   | Reviewed for content and marked as the final version due to the end of the shuttle program | 6/30/2006   |

## LIST OF EFFECTIVE PAGES

The current status of all pages in this document is shown below.

| <u>Page No.</u> | <u>Change No.</u> |
|-----------------|-------------------|
| Preface         | Rev. B            |
| i – v           | Rev. B            |
| 1-1 – 1-23      | Rev. B            |
| 2-1 – 2-38      | Rev. B            |
| 3-1 – 3-22      | Rev. B            |
| 4-1 – 4-11      | Rev. B            |
| A-1 – A-3       | Rev. B            |

## **PREFACE**

The Navigation Aids Workbook, NAVAIDS 21002 was prepared by the United Space Alliance (USA), Flight Operations.

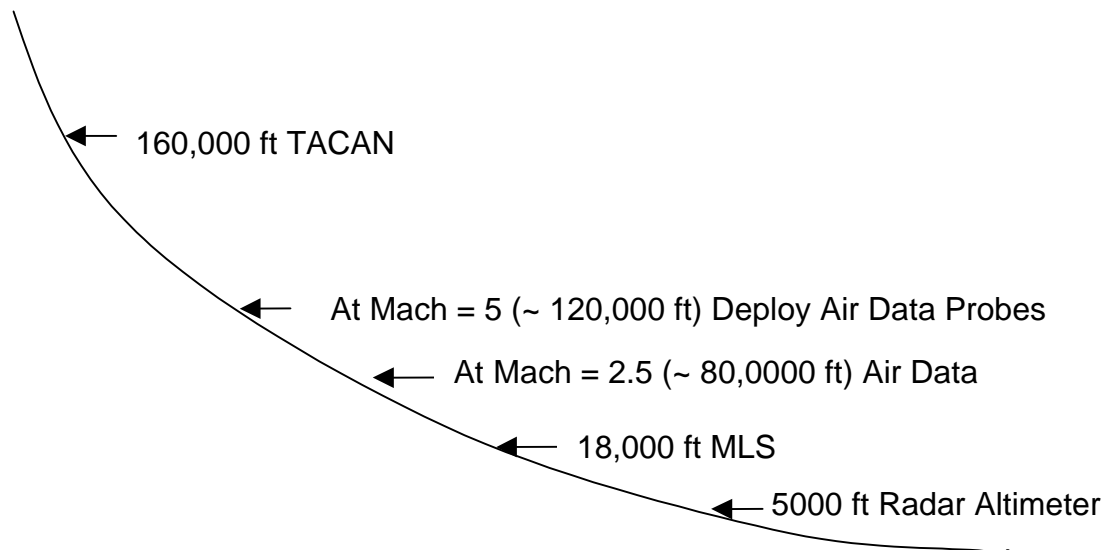
The primary responsibility is with USA, Data Processing System (DPS) Navigation, D/4934.

Questions concerning the technical content of this document should be directed to Kelsey Berumen, 281-244-7667, mail code DT35, D/4934.

## INTRODUCTION

The function of navigation is to maintain an accurate estimate of the vehicle position and velocity. This estimate is called a *state vector*. The current state vector is mathematically determined from the previous state vector by integrating the equations of motion using accelerations of the vehicle. These accelerations are sensed by the Inertial Measurement Units (IMUs) and/or computed from the gravity and drag models. The alignment of the IMUs, and hence the accuracy of the resulting state vector, deteriorates as a function of time. Celestial navigation instruments are used to keep the IMUs aligned while in orbit. The accuracy of the IMU-derived state vector is insufficient by itself for either guidance or the crew to bring the orbiter to a pinpoint landing. Data from entry navigation sensors (Global Positioning System (GPS), Tactical Air Command and Navigation System (TACANs), Air Data Transducer Assembly (ADTA), Microwave Landing System (MLS), and Radar Altimeters (RAs)) are used by GPC navigation and/or the crew during the entry phase to provide the necessary accuracy. The Air Data System (ADS) 21002 workbook is dedicated exclusively to the ADTA navigation sensor. This workbook describes the operation of the GPS, TACANs, the MLS, and the RA Navigation Aids.

## TYPICAL ENTRY FLIGHT PROFILE



## CONTENTS

| Section   | Page        |
|---|-------------|
| <b>1.0 GLOBAL POSITIONING SYSTEM .....</b>          | <b>1-1</b>  |
| 1.1 INTRODUCTION.....                               | 1-1         |
| 1.2 PERFORMANCE OBJECTIVES .....                    | 1-1         |
| 1.3 GPS OVERVIEW .....                              | 1-1         |
| 1.4 ORBITER-RELATED HARDWARE.....                   | 1-3         |
| 1.5 GPS CREW CONTROLS.....                          | 1-4         |
| 1.5.1 Single-String Configuration .....             | 1-4         |
| 1.5.2 Three-String Configuration.....               | 1-5         |
| 1.6 GPS DPS DISPLAYS.....                           | 1-6         |
| 1.6.1 PASS SPEC 50 - HORIZ SIT .....                | 1-6         |
| 1.6.2 PASS SPEC 55 - GPS Status.....                | 1-9         |
| 1.7 GPS FAULT MESSAGES .....                        | 1-15        |
| 1.8 GPS USAGE IN NAVIGATION .....                   | 1-17        |
| 1.9 LAUNCH COMMIT CRITERIA .....                    | 1-17        |
| 1.10 BACKUP FLIGHT SYSTEM DIFFERENCES.....          | 1-17        |
| 1.10.1 BFS DPS Displays .....                       | 1-17        |
| 1.10.2 BFS SPEC 55 - GPS STATUS .....               | 1-19        |
| 1.10.3 Differences.....                             | 1-22        |
| <br>  |             |
| <b>2.0 TACANS.....</b>                              | <b>2-1</b>  |
| 2.1 INTRODUCTION.....                               | 2-1         |
| 2.2 PERFORMANCE OBJECTIVES .....                    | 2-1         |
| 2.3 TACAN GROUND STATION HARDWARE AND OPERATION ... | 2-2         |
| 2.3.1 Bearing.....                                  | 2-2         |
| 2.3.2 Range .....                                   | 2-6         |
| 2.4 ORBITER-RELATED HARDWARE.....                   | 2-6         |
| 2.5 TACAN CREW CONTROLS .....                       | 2-7         |
| 2.6 TACAN DPS DISPLAYS .....                        | 2-11        |
| 2.6.1 SPEC 18 - GNC SYS SUMM 1 Display .....        | 2-11        |
| 2.6.2 SPEC 50 - Horizontal Situation Display .....  | 2-12        |
| 2.6.3 SPEC 40 - Sensor Test Display .....           | 2-15        |
| 2.6.4 SPEC 101 - Sensor Self-Test Display .....     | 2-16        |
| 2.6.5 GPC Fault Messages .....                      | 2-16        |
| 2.7 TACAN SYSTEM SOFTWARE .....                     | 2-17        |
| 2.8 REDUNDANCY MANAGEMENT .....                     | 2-18        |
| 2.9 SELECTION FILTER (SF) .....                     | 2-24        |
| 2.9.1 Three-Level.....                              | 2-24        |
| 2.9.2 Two-Level .....                               | 2-24        |
| 2.9.3 One-Level .....                               | 2-24        |
| 2.9.4 Zero-Level.....                               | 2-24        |
| <br>  |             |
| <b>Section</b>                                      | <b>Page</b> |

|            |  |            |
|------------|--|------------|
| 2.9.5      | “Data Good” (DG) Protection .....                                    | 2-24       |
| 2.9.6      | Post-Selection Filter Protection .....                               | 2-25       |
| 2.10       | FAULT DETECTION, IDENTIFICATION, AND<br>RECONFIGURATION (FDIR) ..... | 2-25       |
| 2.10.1     | Fault Detection .....  | 2-25       |
| 2.10.2     | Fault Identification .....   | 2-26       |
| 2.10.3     | Three-Level .....  | 2-26       |
| 2.10.4     | Two-Level .....  | 2-27       |
| 2.10.5     | Fault Reconfiguration .....  | 2-28       |
| 2.11       | TACAN USAGE IN NAVIGATION .....                                      | 2-29       |
| 2.12       | LAUNCH COMMIT CRITERIA REQUIREMENTS .....                            | 2-35       |
| 2.13       | BFS DIFFERENCES .....  | 2-35       |
| <b>3.0</b> | <b>MICROWAVE LANDING SYSTEM .....</b>                                | <b>3-1</b> |
| 3.1        | INTRODUCTION .....   | 3-1        |
| 3.2        | PERFORMANCE OBJECTIVES .....   | 3-1        |
| 3.3        | MICROWAVE LANDING SYSTEM OPERATION .....                             | 3-1        |
| 3.3.1      | Ground Station Hardware .....  | 3-2        |
| 3.3.2      | Orbiter-Related Hardware .....                                       | 3-5        |
| 3.4        | MICROWAVE LANDING SYSTEM CREW CONTROLS .....                         | 3-7        |
| 3.5        | MICROWAVE LANDING SYSTEM DPS DISPLAYS .....                          | 3-13       |
| 3.5.1      | SPEC 18 - GNC SYS SUMM 1 Display .....                               | 3-13       |
| 3.5.2      | SPEC 40 - Sensor Test Display .....                                  | 3-13       |
| 3.5.3      | SPEC 101 - Sensor Self-Test Display .....                            | 3-14       |
| 3.6        | ORBITER MICROWAVE LANDING SYSTEM SOFTWARE .....                      | 3-15       |
| 3.7        | SUBSYSTEM OPERATING PROGRAM .....                                    | 3-15       |
| 3.8        | REDUNDANCY MANAGEMENT .....  | 3-16       |
| 3.9        | SELECTION FILTER .....   | 3-16       |
| 3.9.1      | Three-Level SF .....   | 3-16       |
| 3.9.2      | Two-Level SF .....   | 3-16       |
| 3.9.3      | One- and Zero-Level SF .....   | 3-17       |
| 3.10       | FAULT DETECTION, IDENTIFICATION, AND<br>RECONFIGURATION .....        | 3-17       |
| 3.10.1     | Three-Level FDIR .....   | 3-17       |
| 3.10.2     | Two-Level FDIR .....   | 3-18       |
| 3.10.3     | One- and Zero-Level FDIR .....                                       | 3-19       |
| 3.11       | MICROWAVE LANDING SYSTEM USAGE IN NAVIGATION .....                   | 3-19       |
| 3.12       | LAUNCH COMMIT CRITERIA REQUIREMENTS .....                            | 3-20       |
| 3.13       | BFS DIFFERENCES .....  | 3-20       |
| <b>4.0</b> | <b>RADAR ALTIMETER .....</b>   | <b>4-1</b> |
| 4.1        | INTRODUCTION .....   | 4-1        |
| 4.2        | PERFORMANCE OBJECTIVES .....   | 4-1        |
| 4.3        | RADAR ALTIMETER OPERATION .....                                      | 4-1        |

Section

Page



|       |   |     |
|-------|---|-----|
| 4.4   | RADAR ALTIMETER CREW CONTROLS.....        | 4-2 |
| 4.5   | RADAR ALTIMETER DPS DISPLAYS.....         | 4-5 |
| 4.5.1 | SPEC 40 - Sensor Test Display .....       | 4-5 |
| 4.5.2 | SPEC 101 - Sensor Self-Test Display ..... | 4-6 |
| 4.6   | RADAR ALTIMETER SOFTWARE .....            | 4-7 |
| 4.7   | LAUNCH COMMIT CRITERIA REQUIREMENTS ..... | 4-8 |
| 4.8   | BFS DIFFERENCES.....                      | 4-9 |

**Appendix**

|          |   |            |
|----------|---|------------|
| <b>A</b> | <b>ACRONYMS AND ABBREVIATIONS .....</b> | <b>A-1</b> |
|----------|---|------------|

## TABLES

### Table

|     |   |      |
|-----|---|------|
| 1-1 | Valid GPS status outputs.....           | 1-10 |
| 1-2 | Valid GPS modes .....                   | 1-11 |
| 1-3 | GPS figure of merit .....               | 1-13 |
| 1-4 | BFS STAT field options .....            | 1-20 |
| 1-5 | BFS MODE field options.....             | 1-21 |
| 2-1 | TACAN RM summary for PASS and BFS ..... | 2-28 |
| 3-1 | MLS-GS and MLS-JR hardware .....        | 3-5  |
| 3-2 | MLS FDIR RM limits .....                | 3-17 |

## FIGURES

### Figure

|      |  |      |
|------|--|------|
| 1-1  | GPS overview .....   | 1-2  |
| 1-2  | Orbits of GPS satellites .....                                   | 1-3  |
| 1-3  | Single-string GPS antenna locations .....                        | 1-4  |
| 1-4  | Single-string GPS switch configuration for OV-104 .....          | 1-5  |
| 1-5  | Three-string GPS switch configuration for OV-105.....            | 1-6  |
| 1-6  | Single-string GPS SPEC 50 horizontal situation display.....      | 1-7  |
| 1-7  | Three-string GPS SPEC 50 horizontal situation display .....      | 1-9  |
| 1-8  | SPEC 55 GPS status.....  | 1-10 |
| 1-9  | GPS minus NAV illustration .....                                 | 1-14 |
| 1-10 | BFS single-string GPS SPEC 50 horizontal situation display ..... | 1-18 |
| 1-11 | BFS three-string GPS SPEC 50 horizontal situation display .....  | 1-19 |
| 1-12 | BFS SPEC 55 GPS STATUS display .....                             | 1-20 |
| 2-1  | TACAN output data .....  | 2-1  |
| 2-2  | Rotating omnidirectional signal with fixed reference .....       | 2-3  |
| 2-3  | Rotating antenna makes signal directionally sensitive.....       | 2-4  |
| 2-4  | Bearing determination .....                                      | 2-5  |
| 2-5  | Orbiter TACAN antenna locations .....                            | 2-6  |
| 2-6  | TACAN DC power on Panels O14, O15, and O16 .....                 | 2-7  |
| 2-7  | TACAN system controls .....                                      | 2-8  |
| 2-8  | TACAN ID controls on Panels O5 and O9 .....                      | 2-9  |
| 2-9  | HSI switch location on Panels F6 and F8 .....                    | 2-10 |
| 2-10 | MEDS HSI .....   | 2-10 |
| 2-11 | PASS GNC SYS SUMM 1 display.....                                 | 2-11 |

| <b>Figure</b>  | <b>Page</b> |
|--|-------------|
| 2-12 BFS GNC SYS SUMM 1 display .....                                | 2-12        |
| 2-13 PASS GNC HORIZ SIT display .....                                | 2-13        |
| 2-14 BFS GNC HORIZ SIT display .....                                 | 2-13        |
| 2-15 Sensor Test SPEC 40 .....                                       | 2-15        |
| 2-16 Sensor Self-Test SPEC 101 .....                                 | 2-16        |
| 2-17 Landing site data chart from entry checklist .....              | 2-18        |
| 2-18 Redundancy management processing .....                          | 2-19        |
| 2-19 Bearing cone of confusion .....                                 | 2-22        |
| 2-20 Forty-degree bearing glitches .....                             | 2-23        |
| 2-21 RM Fail TAC .....   | 2-26        |
| 2-22 RM DLMA TAC .....   | 2-27        |
| 2-23 Entry pocket checklist TACAN RM summary .....                   | 2-29        |
| 2-24 NO COMM TACAN MGMT .....  | 2-35        |
|  |             |
| 3-1 MLS beams and measurement geometry .....                         | 3-2         |
| 3-2 Landing site data from entry checklist .....                     | 3-3         |
| 3-3 MLS-GS major components .....                                    | 3-4         |
| 3-4 MLS antenna locations on orbiter .....                           | 3-6         |
| 3-5 MLS circuit breakers on Panels O14, O15, and O16 .....           | 3-7         |
| 3-6 MLS power switches and channel thumbwheels on Panel O8 .....     | 3-8         |
| 3-7 Horizontal Situation Indicator (HSI) and A/E PFD (for GSI) ..... | 3-10        |
| 3-8 HSI select switches on Panels F6 and F8 .....                    | 3-11        |
| 3-9 HUD display format 1 (approach and landing) .....                | 3-12        |
| 3-10 GNC system summary 1 display .....                              | 3-13        |
| 3-11 Sensor Test .....   | 3-14        |
| 3-12 Sensor Self-Test .....  | 3-15        |
|  |             |
| 4-1 RA antenna location .....  | 4-1         |
| 4-2 RA circuit breakers on Panels O14 and O15 .....                  | 4-2         |
| 4-3 RA power switches on Panel O8 .....                              | 4-3         |
| 4-4 RA tape .....  | 4-4         |
| 4-5 RA tape select switches on Panels F6 and F8 .....                | 4-4         |
| 4-6 On-orbit Sensor Test .....                                       | 4-6         |
| 4-7 Sensor Self-Test .....   | 4-7         |
| 4-8 HUD display with radar altimeter .....                           | 4-8         |

## **1.0 GLOBAL POSITIONING SYSTEM**

### **1.1 INTRODUCTION**

To replace the Tactical Air Command and Navigation (TACAN) system function, National Aeronautics and Space Administration (NASA) decided to use the Department of Defense's NAVSTAR Global Positioning System (GPS) to provide the necessary entry navigation function currently provided by TACAN. Unlike TACAN stations, which are fixed to a point on the Earth, the GPS satellite constellation provides worldwide coverage. As a result, GPS could provide navigation information for all phases of flight. This would minimize or even eliminate the need for ground tracking for what are today routine state vector updates to the orbiter. However, it was decided to limit the single and three-string GPS implementations to the space shuttle orbit and entry phases of flight, not the ascent phase due to limitations of the Primary Avionics Software System (PASS) software. Current operations include a mixed shuttle fleet of single and three-string GPS. GPS will ultimately be used during entry in both configurations.

### **1.2 PERFORMANCE OBJECTIVES**

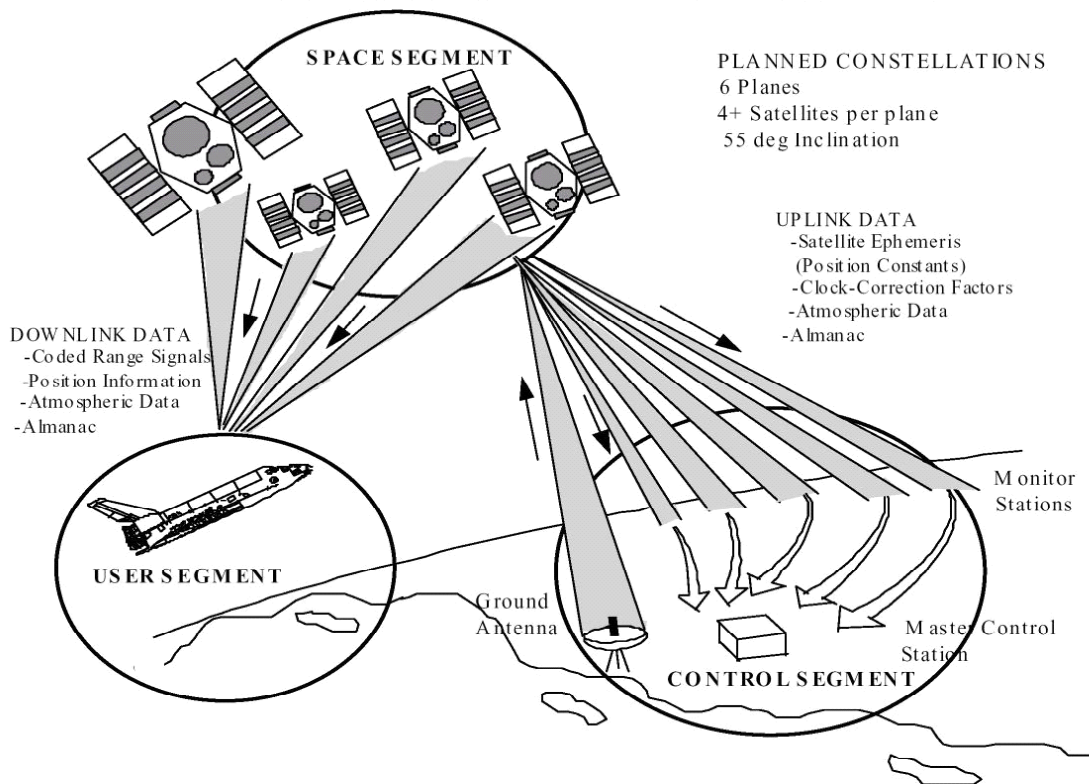
As a result of studying this section, the student should be able to do the following:

- a. Describe the basic GPS system
- b. Describe the single-string orbiter hardware implementation
- c. Recognize the single-string GPS software displays
- d. Describe the three-string orbiter hardware implementation
- e. Recognize the three-string GPS software displays
- f. Describe the GPS differences between the PASS and the Backup Flight System (BFS)

### **1.3 GPS OVERVIEW**

The NAVSTAR GPS is a space-based, radio-positioning navigation system that provides three-dimensional position, velocity, and time information to users anywhere on or near the surface of the Earth. The GPS constellation consists of 27 NAVSTAR satellites, including 3 active on-orbit spares. They operate in 10,980 nautical mile (n. mi.) orbits in six planes, at an inclination of 55° with respect to the equator, and at orbital velocities of 14,500 km/hr.

## MAJOR SEGMENTS OF THE GPS SYSTEM



**Figure 1-1. GPS overview**

The NAVSTAR GPS can be broken into three major pieces or segments:

- The space segment, which consists of NAVSTAR satellites plus active on-orbit spares
- The user segment, which consists of military and civilian receivers
- The control segment, which consists of five unmanned monitor stations, a master control station, and a set of ground antennas installed in widely separated locations around the globe

GPS navigation uses a technique called pseudorange. The pseudorange is the time shift required to align (correlate) a replica of the GPS code generated in the receiver with the received GPS code, scaled into distance by the speed of light. The time shift is the difference between the time of the signal reception (measured in the receiver timeframe) and the time of emission (measured in the satellite timeframe).

As an example, the GPS code broadcast from the satellite is calculated to have a 0.02-second time difference from the GPS code generated in the receiver.

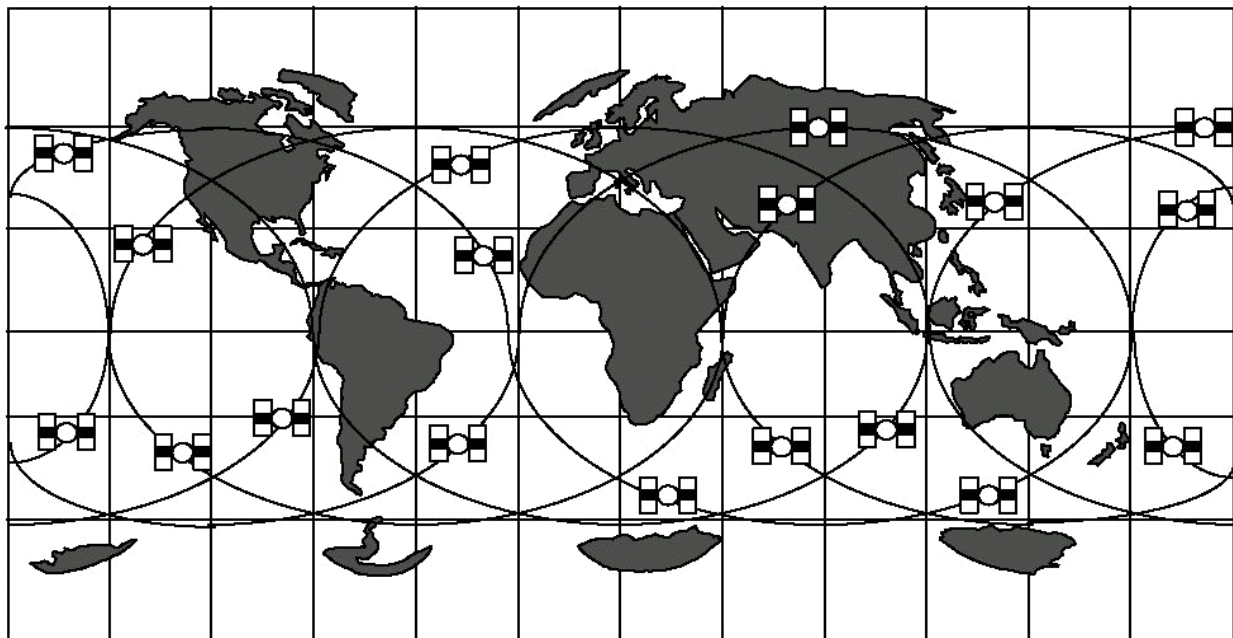
The speed of light is then multiplied by the 0.02-time difference to calculate a distance from the satellite.

$$983571097.9 \text{ ft/s} \times 0.02 \text{ s} = 19671421.758 \text{ ft (3725 miles) from the satellite.}$$

Because there are four unknowns in calculating a position (X, Y, Z, and Time), the range from four satellites is needed to solve for all four unknowns. After identifying a specific satellite (via code-matching techniques), the GPS receiver compares the time at which it received the specific part of the code to the time at which the satellite was supposed to have sent it. This time delta directly corresponds to how far the receiver is from the given satellite. For a receiver to determine exactly where it is near the Earth, it must make such a measurement from three different satellites.

GPS availability has approached 100 percent with a 27-satellite constellation. GPS will provide continuous worldwide coverage. It is expected to be 98 percent reliable, have a continuous fix rate, unlimited system capacity, and no potential for ambiguity.

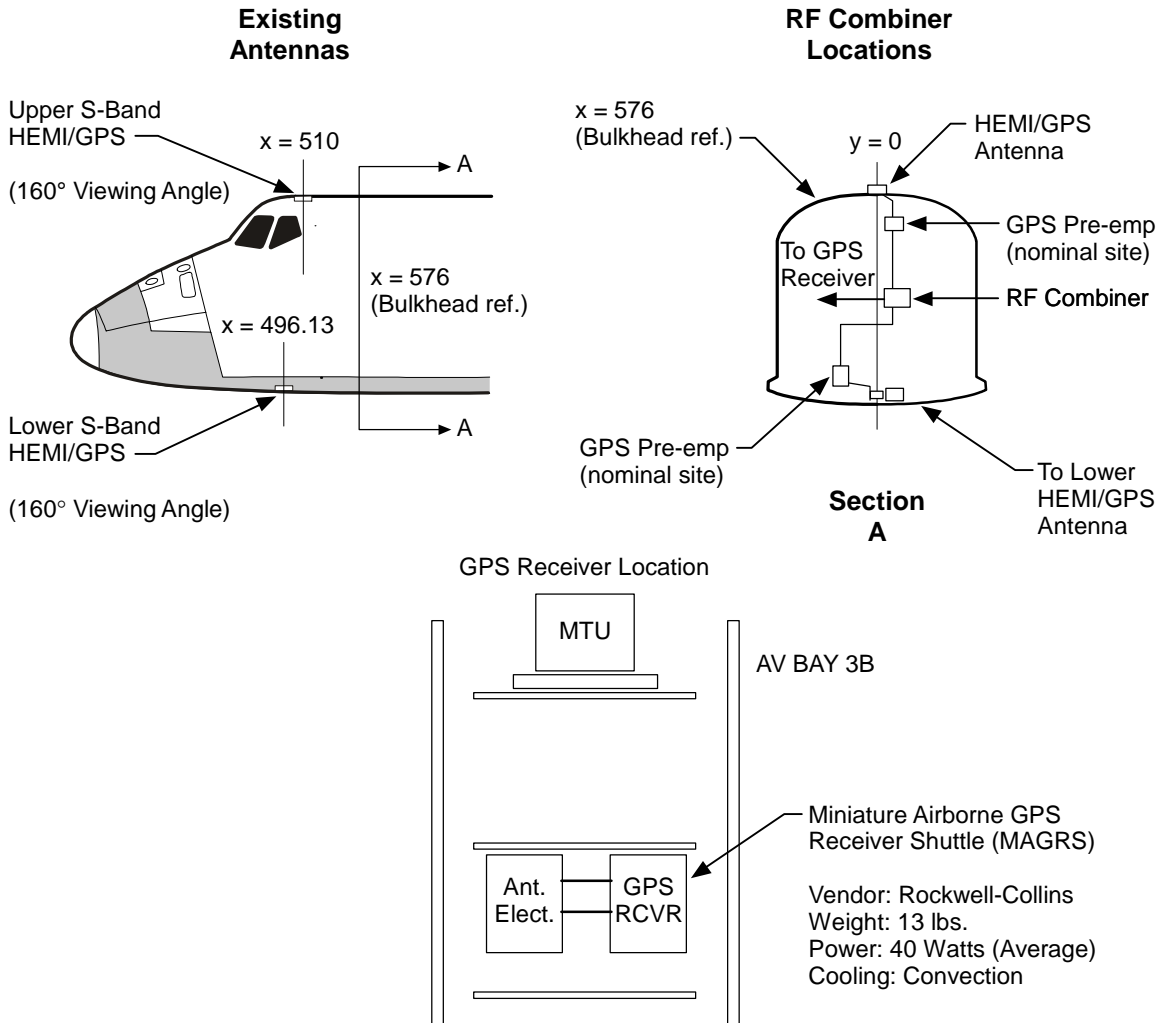
*Figure 1-2* depicts the orbits of the GPS.



**Figure 1-2. Orbits of GPS satellites**

#### **1.4 ORBITER-RELATED HARDWARE**

GPS was deployed in the orbiters in a “single-string” configuration in order to test and evaluate the system. The basic single-string configuration consists of a single GPS receiver located in Avionics Bay 3B, with an upper and lower antenna in the hemi antenna locations (above and below the cockpit). In the single-string implementation, GPS uses the shuttle’s communications (COMM) systems S-band antennas. This configuration is identical for OV-103 and 104. See *Figure 1-3*.



usa006055\_034.cnv

**Figure 1-3. Single-string GPS antenna locations**

The three-string implementation of GPS adds dedicated GPS antennas and switches to the orbiter. Two additional GPS receivers (GPS 1 & 3) are also added to the orbiter for a total of three receivers. The two new receivers are located in AV Bays 1 & 3A respectively. This is the configuration installed on OV-105.

## 1.5 GPS CREW CONTROLS

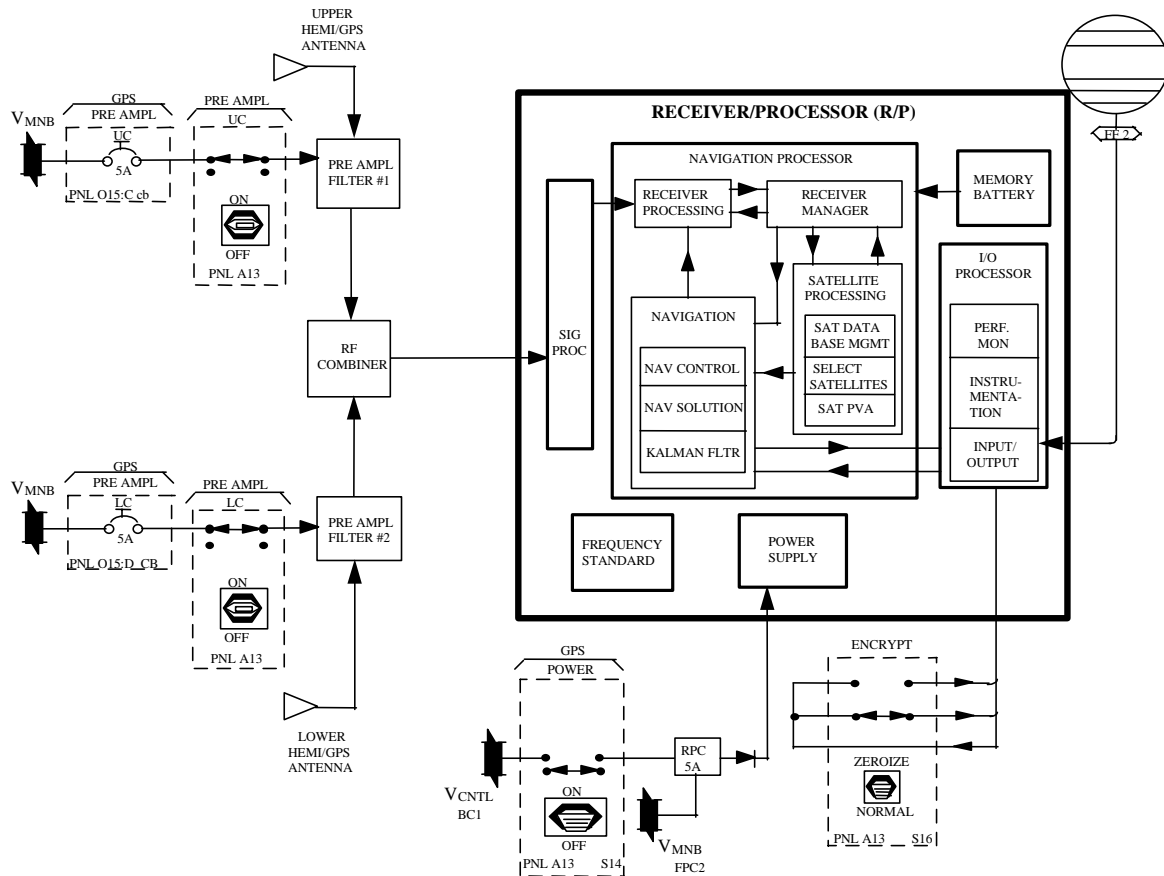
### 1.5.1 Single-String Configuration

The GPS receiver for OV-104 is powered by Main B/FPC2 and CNTL BC1 and its associated switch is located on Panel A13. The preamplifiers (preamps) are powered by Main B O15 and have circuit breakers (cb) on Panel O15 and switches on A13. OV-103 has a different switch and power configuration than OV-104, although it is similar in design. The GPS receiver for OV-103 is powered by Main C/FPC3 and CNTL BC1 and its associated switch is located on Panel A13. The preamps for OV-103 can be powered by either Main A O14 or Main C O16 and have circuit breakers located on

Panels O14 and O16 and switches located on Panel A13. Operationally, both preamps are powered by Main C. Each preamp is powered by a single main bus source. For simplicity, *Figure 1-4* only shows the GPS switch configuration for OV-104.

In addition, an encryption switch has also been installed, which will be moved from the “NORMAL” position to the “ZEROIZE” position for nonapproved landing sites (for security protection). The encrypt switch is powered via internal GPS receiver battery power.

The GPS receiver communicates to the General Purpose Computers (GPCs) via FF2 Multiplexer/Demultiplexer (MDM).



**Figure 1-4. Single-string GPS switch configuration for OV-104**

### 1.5.2 Three-String Configuration

For three-string GPS (OV-105) the receivers for GPS 1, 2, and 3 are powered by Main A/FPC 1/ESS 1BC, Main B/ FPC 2/ESS 2CA and Main C/FPC 3/ESS 3AB respectively. All three receiver power switches are located on Panel O7. The preamps for GPS 1, 2, and 3 are powered by Main A O14, Main B O15 and Main C O16 respectively. All the preamps have power switches on Panel O7 and circuit breakers on Panels O14, O15, and O16 for GPS 1, 2, and 3 respectively. Figure 1-5 shows the three-string GPS switch configuration (OV-105).



The three GPS receivers communicate with the GPCs via FF 1, 2, and 3 MDMs respectively.

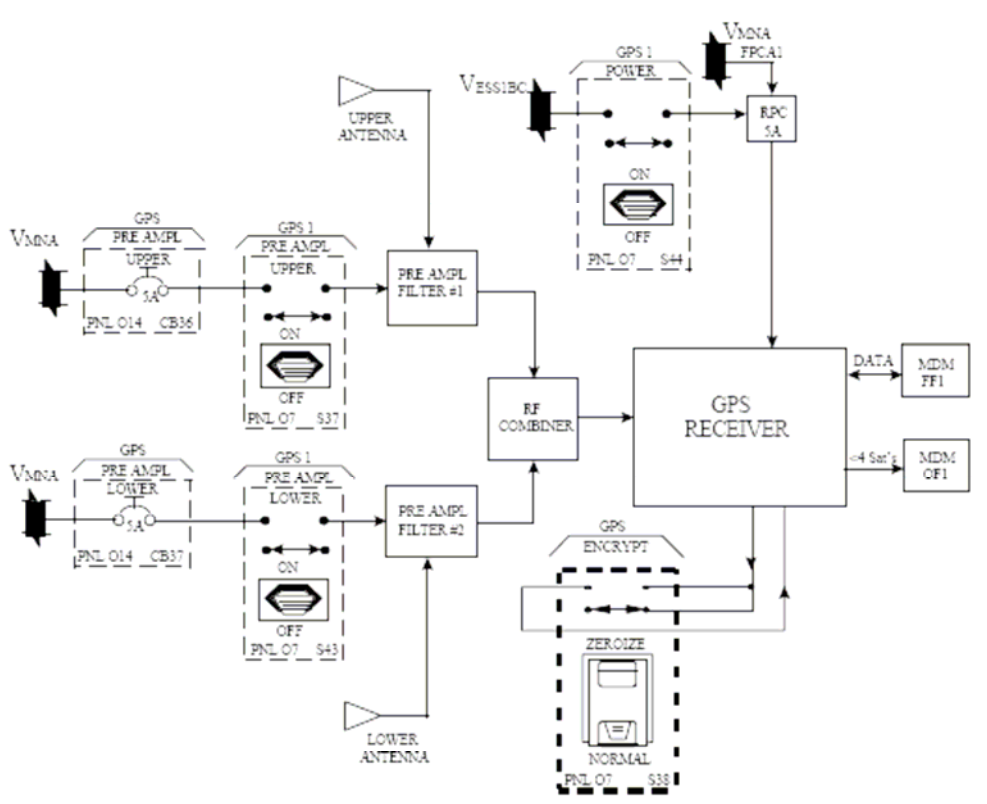


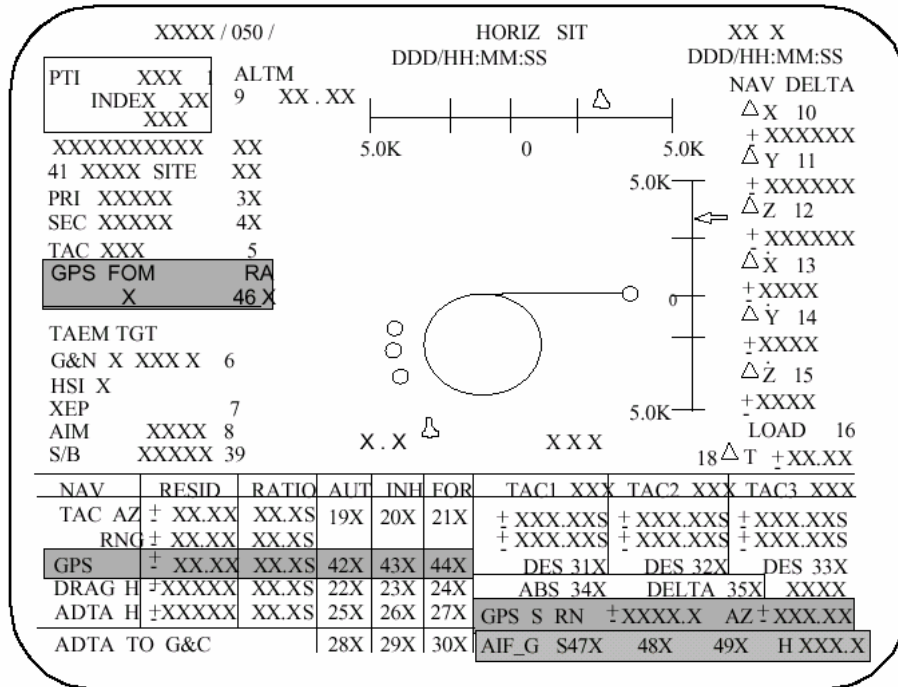
Figure 1-5. Three-string GPS switch configuration for OV-105

## 1.6 GPS DPS DISPLAYS

### 1.6.1 PASS SPEC 50 - HORIZ SIT

#### 1.6.1.1 PASS SPEC 50 - HORIZ SIT (Single-String)

GPS information can be found on PASS SPEC 50 ([Figure 1-6](#)), in addition to all the TACAN data and item entries. An abbreviated set of GPS parameters has been inserted; namely, the commands and data relevant to GPS incorporation into onboard Nav. The shaded areas show the GPS entries on SPEC 50. Descriptions of the GPS entries follow.



**Figure 1-6. Single-string GPS SPEC 50 horizontal situation display**

Toward the top of SPEC 50, the GPS Figure of Merit (FOM) is listed. It is a scaled integer that indicates the accuracy of the GPS Nav state is. The integer represents the total 3D position error that can be expected. The FOM is also known as Quality Assessment 1 (QA 1). An integer value of 1 represents the smallest error, and a value of 9 represents the largest error. The discussion on PASS SPEC 55 contains more information on FOM.

The Radar Altimeter (RA) (Item 46) allows RA data to be used by the GPS receiver. It is initialized in the inhibit state (no\*). Although this item entry exists, it is not enabled; an Item 46 execution results in an “Illegal Entry.”

Toward the bottom of the SPEC are residuals and ratios for the various sensors. GPS is one of them. GPS-NAV RESID is the difference, in nautical miles, between GPS-derived state vector and the navigation (Nav) state vector. GPS-NAV RATIO displays the higher of the position or velocity ratios. A “P” for position or “V” for velocity is indicated immediately preceding the ratio value. A “↓” is displayed to the right of the ratio if the GPS ratio is >1. An “↑” is displayed to the right of the ratio to indicate that a QA OVRD (SPEC 55, ITEM 30) has been commanded and the receiver is a candidate to the Selection Filter (SF).

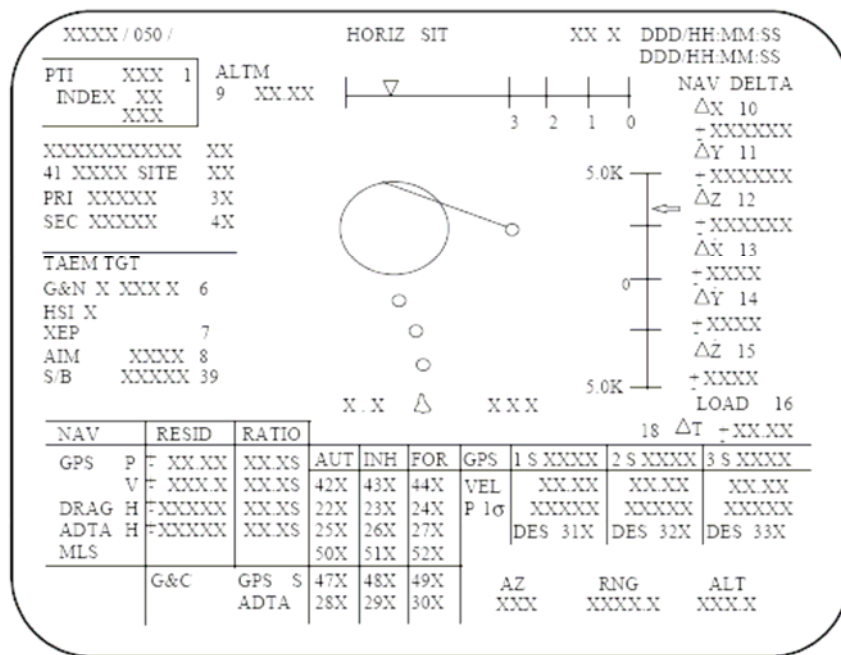
GPS RN, Azimuth (AZ), and H, which are located in the lower right of the display, are the GPS-derived range (n. mi.), bearing (deg), and altitude (kft) to the TACAN station. They can be used for TACAN comparison.

The Item entries (Items 42, 43, and 44) for Auto, Inhibit, and Force (AIF) to Nav controls the incorporation of GPS data into Nav. These items default to the Inhibit (INH) position at Operational Sequence (OPS) transitions and should remain there throughout the flight. In PASS, a Force (FOR) to Nav is a one-time occurrence. The AIF function returns to the previous position on the next Nav cycle. When Automatic (AUTO) is selected, the GPS updates the state vector every I-load period of time. Currently, the I-load value for orbit is 90 minutes. For ascent and entry, the I-load is set to 40 seconds until 17,000 feet, when it increases to 9 seconds.

The Item entries (Items 47, 48, and 49) for AIF\_G can be used to incorporate a GPS vector into Guidance and Control (G&C). For a commanded FORCE of GPS to G&C, the GPS 2 receiver state is incorporated into G&C provided that: no Data Good Fail flag is set, and the receiver is not deselected by the crew. Unlike the GPS to Nav FORCE command, the GPS to G&C FORCE condition remains until another selection is made.

#### **1.6.1.2 PASS SPEC 50 - HORIZ SIT (Three-String)**

The three-string GPS HORIZ SIT display is similar to the single-string display. The GPS Figure of Merit (FOM) and RA to GPS have been removed. Since there are no TACAN units onboard, the TACAN residuals and ratios have been removed, along with the Item entries for AIF (Items 19, 20 and 21). The individual TACAN Line Replacement Unit (LRU) residuals have been replaced by the individual GPS LRU residuals. The GPS residual and ratios for position and velocity have been separated so that each is on its own line. Also added are the Item entries (Items 50, 51 and 52) for AIF to control the incorporation of MLS to Nav. MLS is defaulted to the Auto mode. [Figure 1-7](#) depicts the PASS SPEC 50 (three-string) display.



**Figure 1-7. Three-string GPS SPEC 50 horizontal situation display**

**1.6.2 PASS SPEC 55 - GPS Status**

On PASS SPEC 55 ([Figure 1-8](#)), the status for GPS is displayed. The shaded area of the figure is used with three-string GPS. During single-string operations, only the data and Item entries applicable to GPS number 2 are activated. Any commands addressing noninstalled units are regarded as illegal entries. In addition to the data associated with GPS units 1 and 3 being blanked, all data related to Quality Assessment 4 (QA4) is also deactivated. QA4 requires at least two units for relative comparison; all other QA data is still applicable to a single GPS receiver.

Next to the GPS unit number is a status indicator. Nominally, it should be blank to indicate good status. Other options are a down arrow and a question mark. The down arrow indicates that GPS is not available. A question mark indicates that it is in dilemma (three-string GPS only).

Input/Output (I/O) (Item 10) is designed to control receiver I/O during GNC OPS 9. It is used by the ground, not the crew.

The STAT field gives an indication of the receiver status. Nominally, the crew sees it blank. Possible indications are listed in [Table 1-1](#).

| XXXX / 055 / |          | GPS STATUS |         |                        | XX X DDD/HH:MM:SS<br>DDD/HH:MM:SS |                   |  |
|--------------|----------|------------|---------|------------------------|-----------------------------------|-------------------|--|
| I/O 10 X     | GPS 1 S  | GPS 2 S    | GPS 3 S | GPS MINUS NAV          |                                   |                   |  |
| STAT         | XXXX     | XXXX       | XXXX    | $\Delta H \pm$ XXXXXX  | $\Delta H \pm$ XXX.XX             |                   |  |
| MODE         | XXXX     | XXXX       | XXXX    | $\Delta DR \pm$ XXXXXX | $\Delta DR \pm$ XXX.XX            |                   |  |
| S/TEST       | 11 X S   | 12 X S     | 13 X S  | $\Delta CR \pm$ XXXXXX | $\Delta CR \pm$ XXX.XX            |                   |  |
| INIT         | 14 X     | 15 X       | 16 X    | X LAT                  | X LON                             | ALT               |  |
| NAV          | 17 X     | 18 X       | 19 X    | XX.XX                  | XXX.XX                            | XXX.XXXX          |  |
| RESTART      | 20 X     | 21 X       | 22 X    |                        |                                   |                   |  |
| GDOP         | XX       | XX         | XX      |                        |                                   |                   |  |
| DG FAIL      | S        | S          | S       | AUT INH FOR            |                                   |                   |  |
| DES RCVR     | 26 X     | 27 X       | 28 X    | GPS TO G&C             | S 32 X                            | 33 X 34 X         |  |
| QA 1 FOM     | X S      | X S        | X S     | GPS TO NAV             | 35 X                              | 36 X 37 X         |  |
| QA 2 POS     | X.XX S   | X.XX S     | X.XX S  | METERING OVERRIDE 38 X |                                   |                   |  |
| VEL          | X.XX S   | X.XX S     | X.XX S  | SATELLITES             |                                   |                   |  |
| QA 3 POS     | X.XX S   | X.XX S     | X.XX S  | TRKD                   | C1                                | C2 C3 C4 C5 C6    |  |
| VEL          | X.XX S   | X.XX S     | X.XX S  | GPS 1                  | XX                                | XX XX XX XX XX XX |  |
|              | 1-2      | 2-3        | 3-1     | GPS 2                  | XX                                | XX XX XX XX XX XX |  |
| QA 4 POS     | X.XX S   | X.XX S     | X.XX S  | GPS 3                  | XX                                | XX XX XX XX XX XX |  |
| VEL          | X.XX S   | X.XX S     | X.XX S  | REQ 39                 | XXS                               | XXS XXS XXS       |  |
| QA OVRD      | 29 X S   | 30 X S     | 31 X S  | DES 43                 | XX                                | XX XX XX XX       |  |
| SF CAND      | X        | X          | X       |                        | XX                                | XX XX XX XX       |  |
| XXX.X        | LAST SEL | FIL UPDATE |         |                        |                                   |                   |  |

Figure 1-8. SPEC 55 GPS status

Table 1-1. Valid GPS status outputs

| Display          | Message description                        |
|------------------|--|
| NI               | Receiver is not installed                  |
| M (Overbright)   | Communication fault                        |
| BIT              | Receiver Built-In Test in progress         |
| RPF (Overbright) | Receiver Processor Failure                 |
| BATT             | GPS battery low                            |
| DGF              | GPS Data Good Failure                      |
| (blank)          | Nominal operation – No GPS-related anomaly |

A receiver processor failure causes a Class 3 alarm and a GPC fault message “G55 GPS FAIL X.” This field will show “NI” for GPS 1 and 3 during single-string operations.

MODE is an indication of the receiver's current mode of operation. The possible modes and a brief description are listed in

*Table 1-2.* Normally, the crew will see Inertial Navigation System (INS) during the flight.

**Table 1-2. Valid GPS modes**

| Display | Message description                                 |
|---------|---|
| INIT    | Initialization mode                                 |
| TEST    | Self-test mode                                      |
| INS     | Inertial Navigation System navigation submode       |
| PVA     | Position, Velocity, Acceleration navigation submode |
| site    | Three-character vehicle location mnemonic           |
| blank   | Receiver is not in an operating mode                |

INIT indicates that the receiver is in the initialization submode. When the receiver is commanded to the initialize mode, it resets its Nav solution and looks to the GPC to provide it with a state vector to aid the receiver in knowing where it is.

TEST indicates that the receiver is in self-test mode. It will be seen only if the crew manually commands a self-test.

INS indicates that the receiver is in the INS navigation submode. In this submode, the GPC is continually supplying a state vector to the receiver. This aiding data helps the receiver to fine-tune its own state vector.

PVA indicates that the receiver is in the Position, Velocity, Acceleration (PVA) navigation submode. In this submode, the GPS receiver is not receiving valid aiding data from the GPC. This means that the GPS solution may be slightly less accurate than it would be in INS.

Site is a three-character vehicle location mnemonic. Bottom line: prelaunch (OPS 901 and 101), some numbers are displayed to indicate the IMU calibration site. For postlanding (OPS 901), a three-letter designator for the landing site (i.e., KSC, BEN, etc.) is displayed.

When a blank is seen in the Mode field, the receiver is not in an operating mode.

Upon powering up the receiver, the receiver automatically enters a 30-second "Power-On Built-In (POB) Test," during which the receiver remains commfaulted with the GPC.

Until the commfault is cleared, the MODE field continues to show blank. If the I/O RESET is performed right at the completion of the POB, the STAT field shows "BIT" for a few seconds, then blank, and the MODE field displays "INIT." Upon completion of the INIT, the receiver automatically enters the navigation mode, first "PVA," then "INS" when it has acquired four satellites.

There are several operating modes for GPS. They are TEST, INIT, and NAV. Item 11, 12, or 13 initiates a self-test on the GPS unit. The self-test uses the GPS receiver's Built-In-Test (BIT). The self-test takes about 2 minutes during the test there is no output from the receiver. "BIT" is displayed while the self-test is in progress. When the self-test is completed, the receiver remains in TEST mode until an Item entry is made to transition it to the INIT or NAV mode. A status indicator is displayed to indicate if the receiver passed or failed the self-test. An up arrow is shown next to Items 11, 12, and 13 if the test is completed successfully, or a down arrow is shown if it failed the self-test. The status indicator is blank during the self-test. An Item 14, 15, or 16 takes the unit to an INIT mode. INIT mode allows the GPS receiver to obtain a current position, velocity, and time from the GPC. There will be no indication that the receiver has completed initialization. An Item 17, 18, or 19 puts the receiver into the NAV mode, where it outputs a state vector. If the receiver is commanded to NAV mode before finishing a self-test or initialization, the receiver transitions to the NAV mode as soon as it completes them.

Item 21 will RESTART the receiver. It is available only in the INS mode. This command causes the receiver to open the covariance matrix in its internal Kalman navigation filter. The asterisk disappears next to the Items 20, 21, and 22 when the filter restart operation is complete.

GDOP stands for the Geometric Dilution of Precision. In other words, it is the receiver's indication of how good the geometry is between the tracked satellites. This parameter ranges from 1 to 15, with smaller numbers indicating better satellite geometry.

Data Good Fail (DG FAIL) indicates the validity of the receiver's state vector. A yellow "↓" or a blank is displayed, depending on the status of the DG FAIL flag. The down arrow is displayed if in NAV mode and the receiver data are invalid or the receiver state timetag is more than 3.84 seconds older than the current navigation filter state time tag. Nominally, it should be blank.

DES RCVR (Items 26, 27, and 28) allows for manual deselection of the receiver from the SF. A blank next to the item entry indicates that the receiver is selected. An asterisk indicates that it has been deselected.

QA OVRD (Items 29, 30, and 31) allows the user to override the outcome of the QA checks as described below and allows the receiver to be a SF candidate. A yellow "↓" is displayed in the parameter status field to indicate that the override is not being honored when the QA OVRD is set and a receiver DG failure or a receiver deselect is active. QA data continues to be calculated, regardless of the status of the QA override. A QA OVRD does not override a receiver DG failure or a crew deselection.

SF CAND field indicates whether the state vector for the given receiver is a candidate for GPS state SF (\*) or not (no \*). To be considered a candidate for selection, the receiver cannot have been deselected, must have valid data, must pass all QA1, QA3, and QA4 QAs (unless a QA override has been done), or it has been forced to G&C.

Note: QA2 quality assessment does not impact a receiver's capability to be an SF candidate.

The QA section provides quality assessment information on the GPS data.

QA1 P  $1\sigma$  displays the FOM for the receiver. This parameter is an indication from the receiver as to how accurate it thinks its Nav solution is with respect to position. Refer to [Table 1-3](#) for displayed values. FOM must be less than 3 in OPS 2/8 and less than 6 in OPS 1/3/6/9 for Nav to incorporate GPS data. FOM is blank if the GPS receiver is not in NAV mode or if the GPS data is invalid.

**Table 1-3. GPS figure of merit**

| FOM (integer)<br>SPEC 50 | Corresponding<br>error (m) | Position error (P),<br>one sigma ( $1\sigma$ ) (feet)<br>SPEC 55 |
|--------------------------|----------------------------|--|
| 0                        | 0                          | (blank)  |
| 1                        | <25                        | 75   |
| 2                        | 25 to 50                   | 175  |
| 3*                       | 50 to 75                   | 250  |
| 4                        | 75 to 100                  | 325  |
| 5                        | 100 to 200                 | 650  |
| 6*                       | 200 to 500                 | 1650   |
| 7                        | 500 to 1000                | 3275   |
| 8                        | 1000 to 5000               | 16400  |
| 9                        | > 5000                     | 99999  |

QA2 POS & VEL checks how well the GPS state vector is agreeing with the PASS Nav state vector. Although the flight software computes a ratio for all six positions and velocity components, only the maximum ratio for each is displayed. The position and velocity ratios are computed by differencing the navigation state and the GPS state in Local Vertical quasi-inertial coordinate system with components U, V & W (UVW) coordinates and dividing each by the UVW maximum allowable residual. In major modes 304, 305, 602, and 603, the UVW coordinate system will be an Earth relative coordinate system. For all other major modes where the residuals are calculated, they will be in an inertial coordinate system.



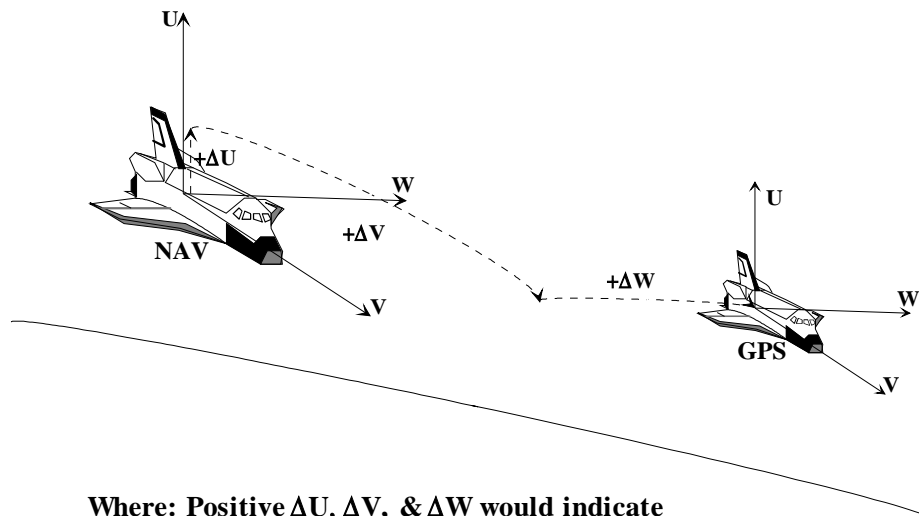
QA3 POS & VEL checks the stability of the GPS velocity and position estimates. The assessment computes the difference between the current GPS state and the previous state propagated to the current Nav filter time. These differences are then divided by an I-load tolerance.

QA4 POS & VEL is not applicable to single-string GPS operations. In three-string GPS operations, it compares the GPS receivers to one another.

If a QA1, QA3, or QA4 check fails, an overbright “↓” is driven next to the failed parameter. A QA1, QA3, or QA4 failure causes the GPS state vector to be unavailable to the SF. A QA2 failure is the only exception.

The LAST SEL FIL UPDATE field displays the number of minutes since the last valid GPS state was selected by the PASS GPS SF; basically, the time since no GPS states were made available to the SF. The time is reset to zero at an OPS transition, after an on-orbit Initial Program Load (IPL), when GPS receiver data updates the selected state, and when the receiver is not available. The field is blanked until a selected GPS state vector becomes available.

The GPS MINUS NAV section displays the difference between the selected GPS state and the PASS Nav state in UVW coordinates (i.e., altitude ( $\Delta H$ ), downrange ( $\Delta DR$ ), and crossrange ( $\Delta CR$ )). The units are ft and ft/sec. It is an indication of where GPS thinks you are relative to where Nav thinks you are. For example: if all the GPS MINUS NAV values are positive, GPS thinks you are in front, above, and to the left of Nav (as shown in [Figure 1-9](#)).



Where: Positive  $\Delta U$ ,  $\Delta V$ , &  $\Delta W$  would indicate GPS is above, ahead, & left of NAV, respectively.

**Figure 1-9. GPS minus NAV illustration**

The LAT, LON, ALT section displays GPS computed Latitude (LAT), Longitude (LON), and Altitude (ALT). Altitude is displayed in nautical miles until major mode 304 or 602;

the altitude is then displayed in kft. Latitude is preceded with an “N” or “S,” and Longitude is preceded with an “E” or “W” and is measured from the Greenwich meridian. It can be used to give vehicle location for bailout situations.

The GPS TO G&C and NAV Item entries (Items 32, 33, 34, 35, 36, and 37) are identical in function to those on SPEC 50. They control the incorporation of GPS data into NAV and G&C. These items default to the INH position at OPS transitions and should remain there throughout the flight (except during Detailed Test Objectives (DTOs) operations). FORCE to Nav (Item 37) is a one-time occurrence. The AIF function will return to the previous position on the next Nav cycle. For a commanded FORCE of GPS to G&C (Item 34), the GPS receiver state is automatically made available to the GPS SF and incorporated into G&C provided that: no Data Good Fail is set and the receiver is not deselected by the crew. Unlike the GPS to NAV FORCE command (Item 37), the GPS to G&C FORCE (Item 34) condition remains until either Item 32 or 33 is selected. An Item 32 to take GPS to G&C to AUTO will have the software automatically update the User Parameter Processing (UPP) state vector with the selected GPS state vector every navigation cycle, rather than resetting the UPP state with the selected navigation filter state. An Item 33 will inhibit software from updating the UPP state vector with a GPS state vector.

METERING OVERRIDE (Item 38) disables the metering of updates to the UPP state when in Auto or Force. In other words, state vector updates made to UPP are incorporated all at once instead of at a controlled rate.

The SATELLITES section displays the current satellites being tracked by the receiver. Since the current GPS receiver onboard has only a five-channel receiver, the data for channel 6 is blank. The data for these fields ranges from blank to 63. There are only 27 satellites currently in the GPS satellite constellation. They are numbered consecutively.

DES (Item 43) allows manual deselection/reselection of satellites from the receivers. The positive delimiter is used to deselect a satellite; the negative delimiter is used to reselect a satellite. For example, to deselect satellite number 24, one would type ITEM 43 + 24 EXEC. If you wish to reselect that satellite, you would type ITEM 43 - 24 EXEC.

## **1.7 GPS FAULT MESSAGES**

The following are the possible GPS fault messages and the conditions that cause them. When the message is available in PASS only, it is indicated following the description.

- a. “BCE STRG 2 GPS” - Loss of I/O with the receiver. Crew should work DPS “BCE STRG X” procedure as time permits.
- b. “G55 QA FL GPS 2” - Failed one of the QA 1, 3, or 4 checks. (PASS only)
- c. “G55 GPS FAIL 2” - Indicates a receiver processor failure. Will see a yellow “RPF” in STAT field on SPEC 55. (PASS only)

- d. "NAV EDIT GPS" - Selected GPS state vector exceeded threshold or no GPS vector was selected below 140 kft (applies only when GPS is taken to Auto).

- e. "NO UPDATE GPS" - A valid GPS state vector has not been selected for an I-loaded period of time. Due to current I-load settings, this message should not be seen in flight.
- f. "RM DLMA GPS" – QA4 miscomparison between two or three GPS receivers. (PASS only)

## **1.8 GPS USAGE IN NAVIGATION**

GPS is intended to replace the entry navigation function currently provided by the TACANs. Currently, however, GPS is not used on a nominal basis as an entry navigation aid. It is available for emergency use to correct a bad onboard state vector. If the onboard Nav state is not considered acceptable, the preferred method is to force GPS to fix it. After forcing GPS, PASS continues to propagate its state vector with the good NAVAID information (TACAN, Air Data, etc.). The good PASS state vector is then transferred to the BFS to correct its errant Nav state as well. The only current use of GPS during orbit is to provide a good state vector in the event of an unresolved communications outage.

GPS use continues to become more mainstream as plans to slowly incorporate nominal GPS usage take place. Starting with STS-121 and continuing with subsequent flights, GPS will be used during entry starting at various timeframes for BFS and later with PASS. After these tests are completed, GPS will be available to be used in Auto throughout entry for PASS and BFS. GPS use is not allowed in OPS 302 (Deorbit Burn), so it will be inhibited during this phase of flight.

Since on a three-string flight there are no TACANs, GPS will be used during entry. The first three-string flight is currently scheduled for early in 2007.

## **1.9 LAUNCH COMMIT CRITERIA**

Currently, GPS is considered a backup to TACAN 2 before launch on OV-104 only. Either TACAN 2 or GPS 2 is required before launch. This requirement does not apply to OV-103 due to differences in the power configuration between the orbiters. OV-105 will have different requirements since it has three GPS receivers and no TACANs. These requirements have not been specified at this time.

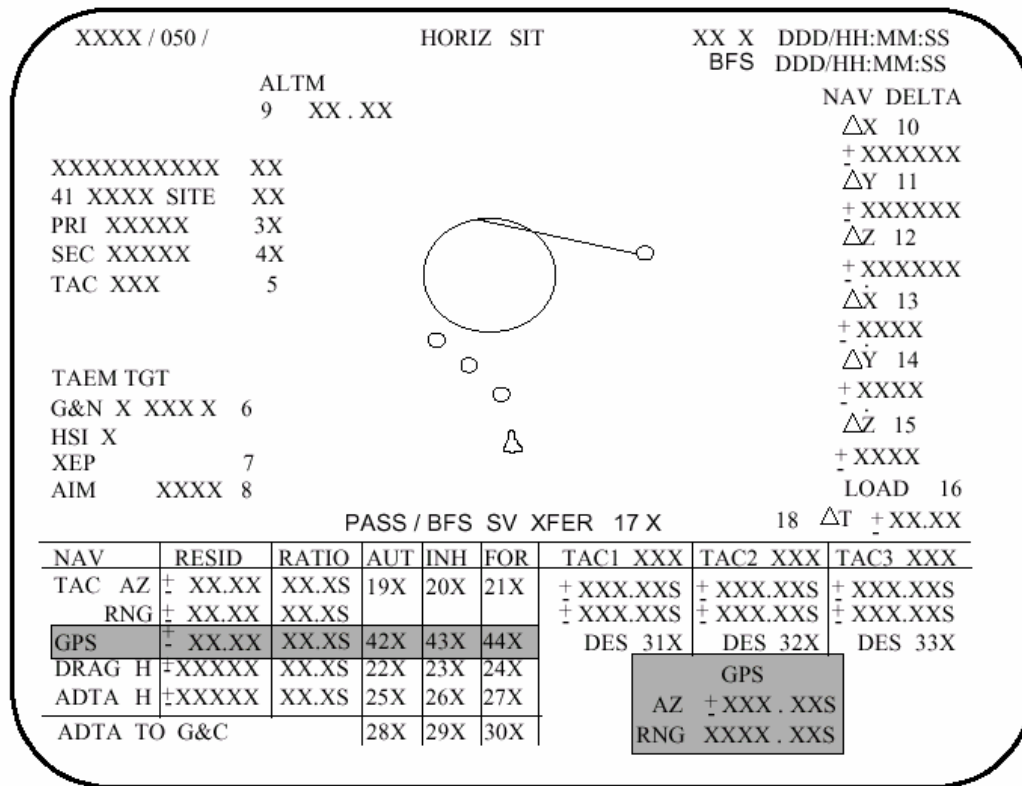
## **1.10 BACKUP FLIGHT SYSTEM DIFFERENCES**

### **1.10.1 BFS DPS Displays**

#### **1.10.1.1 BFS SPEC 50 - HORIZ SIT (Single-String)**

BFS SPEC 50 (see [Figure 1-10](#)) provides slightly different GPS information than the PASS SPEC 50. Just like PASS, it displays the RESID and RATIO for GPS. The residual represents the position difference (in n.mi.) between the GPS and onboard Nav state vectors. The ratio is the GPS position residual data divided by the maximum

allowable residual (an I-loaded value). BFS always displays the position ratio. PASS shows either the position or velocity ratio. Like PASS, a “↓” is displayed to the right of the ratio if either the position OR velocity ratio is >1. Also, the GPS-to-Nav incorporation flags (Items 42, 43, and 44) are available. BFS will default to inhibit (Item 43). Its state vector will not be updated by GPS. When GPS to Nav is in Auto, the BFS state vector is updated with the GPS state vector if the ratio is less than or equal to one. When GPS is forced to Nav (Item 44), it continuously updates the GPC Nav state vector with a GPS state vector. In the lower right corner of the display, BFS also displays the GPS-derived value for azimuth (actually, bearing) and range to the selected TACAN Ground Station (GS). Azimuth (bearing) is displayed in degrees, and range is shown in nautical miles. This information allows a direct comparison to TACAN data, which is co-located on the display.

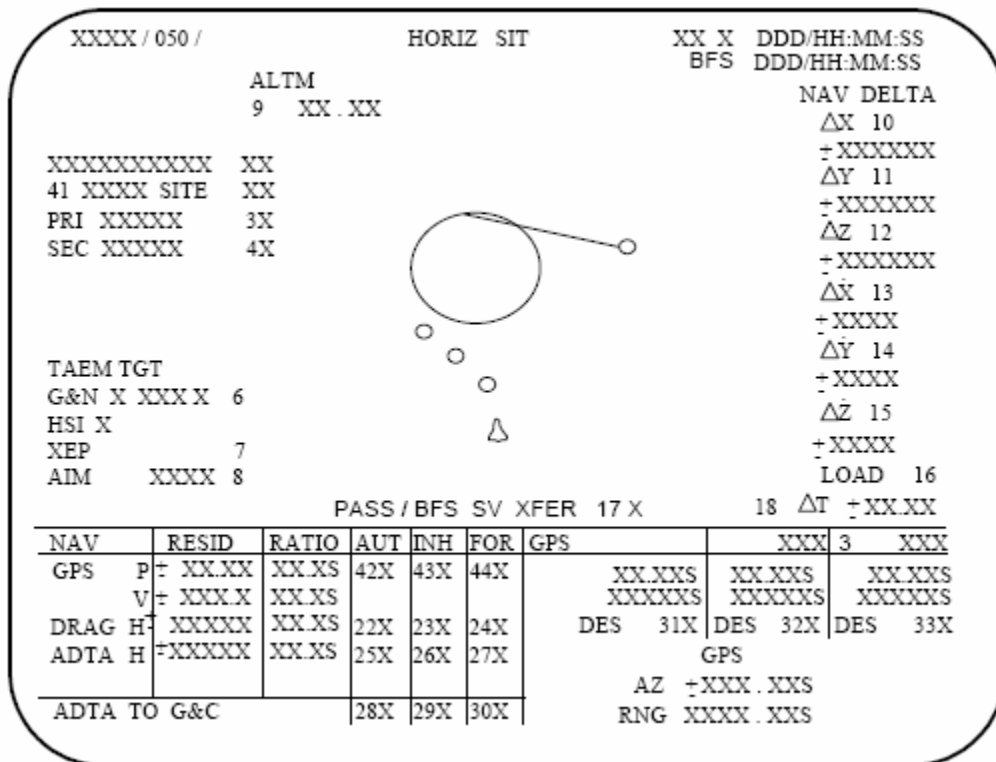


**Figure 1-10. BFS single-string GPS SPEC 50 horizontal situation display**

**1.10.1.2 BFS SPEC 50 - HORIZ SIT (Three-String)**

Like PASS, the BFS HORIZ SIT display (three-string) is similar to the single string display. The TACAN residuals and ratios have been removed, along with the Item entries for AIF (Items 19, 20, and 21). The individual TACAN LRU residuals have been replaced by the individual GPS LRU residuals. The GPS residual and ratios for position

and velocity have been separated to their own line. *Figure 1-11* depicts the BFS SPEC 50 (three-string) display.



**Figure 1-11. BFS three-string GPS SPEC 50 horizontal situation display**

### 1.10.2 BFS SPEC 55 - GPS STATUS

BFS SPEC 55 (see *Figure 1-12*) provides the crew capability to monitor the GPS receiver along with the necessary Item entries. The BFS SPEC 55 does not have the full amount of data displayed that the PASS SPEC 55 does.

During single-string operations, only the data and Item entries applicable to GPS number 2 are activated. Any commands addressing noninstalled units are regarded as illegal entries.

Next to the GPS unit number is a status indicator. Nominally, it should be blank to indicate good status. Other options are a down arrow and a question mark. The down arrow indicates that GPS is not available. A question mark indicates that a receiver is not available due to a receiver to receiver miscomparison (which will only be seen in three-string GPS operations).

The STAT field gives an indication of the receiver status. Nominally, the crew will see it blank. Possible indications are listed in *Table 1-4*. A receiver processor failure will

cause a Class 3 alarm and a GPC fault message “G55 GPS FAIL 2.” This field will show “NI” for GPS 1 and 3 for single-string operations.

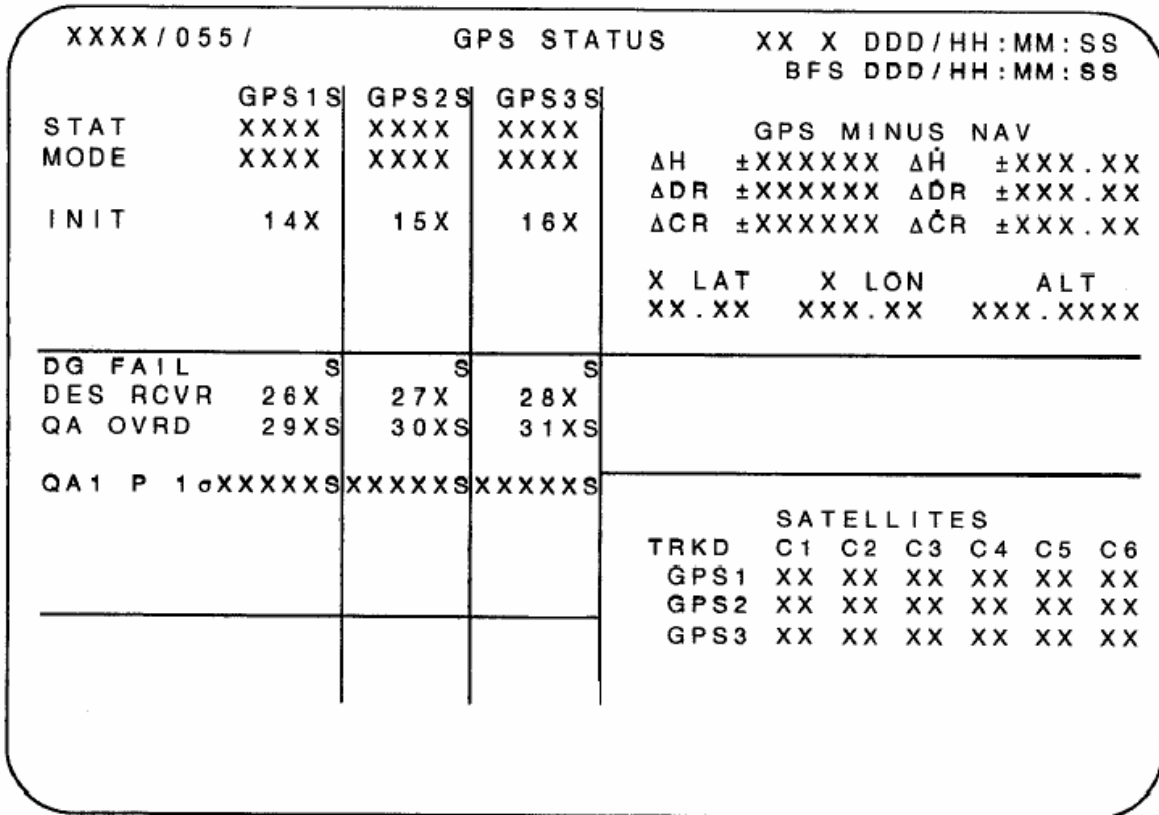


Figure 1-12. BFS SPEC 55 GPS STATUS display

Table 1-4. BFS STAT field options

| Characters displayed | Message description                    |
|----------------------|--|
| NI                   | Receiver not installed                 |
| Blank                | No GPS anomaly, nominal operation      |
| M (Yellow)           | Communication fault                    |
| BIT                  | Built-In Test in progress              |
| RPF (Yellow)         | Receiver/Processor Failure             |
| BATT                 | Receiver/processor battery voltage low |
| DGF                  | Data Good Fail                         |

MODE is an indication of the receiver’s current mode of operation. The possible modes and a brief description are listed in [Table 1-5](#). Normally, the crew will see INS during the flight.

**Table 1-5. BFS MODE field options**

| <b>Characters displayed</b> | <b>Message description</b>                       |
|-----------------------------|--|
| Blank                       | Receiver not in an operating mode                |
| INIT                        | Receiver in Initialization mode                  |
| TEST                        | Receiver in self-test mode                       |
| INS                         | Receiver in aided Navigation submode             |
| PVA                         | Receiver in unaided Navigation submode           |
| STA                         | Receiver in prelaunch standby navigation submode |

INIT indicates that the receiver is in the initialization submode. When the receiver is commanded to the initialize mode, it resets its Nav solution and looks to the GPC to provide it with a state vector to aid the receiver in knowing where it is.

TEST indicates that the receiver is in self-test mode. It will be seen only if the crew manually commands a self-test.

INS indicates that the receiver is in the INS navigation submode. In this submode, the GPC is continually supplying a state vector to the receiver. This aiding data helps the receiver to fine tune its own state vector.

PVA indicates that the receiver is in the Position, Velocity, Acceleration navigation submode. In this submode, the GPS receiver is not receiving valid aiding data from the GPC. This means that the GPS solution may be slightly less accurate than it would be in INS.

When a blank is seen in the Mode field, the receiver is not in an operating mode.

Upon powering up the receiver, the receiver automatically enters a 30-sec POB, during which the receiver remains commfaulted with the GPC. Until the commfault is cleared, the MODE field continues to show blank. If the I/O RESET is performed right at the completion of the POB, the STAT field shows "BIT" for a few seconds, then blank, and the MODE field displays "INIT." Upon completion of the INIT, the receiver automatically enters the PVA navigation mode and then the INS navigation mode when it has acquired four satellites.

An Item 14, 15, or 16 will take the unit to an INIT mode. INIT mode allows the GPS receiver to obtain a current position, velocity, and time from the GPC. There will be no indication that the receiver has completed initialization.

Data Good Fail (DG FAIL) indicates the validity of the receiver's state vector. A yellow "↓" or a blank is displayed, depending on the status of the DG FAIL flag. The down



arrow is displayed if in navigation submode and the receiver data are invalid or the receiver state timetag is more than 3.84 seconds older than the current navigation filter state timetag. Nominally, it should be blank.

DES RCVR (Item 27) allows for manual deselection of the receiver from the SF. A blank next to the Item entry indicates that the receiver is selected. An asterisk indicates that it has been deselected.

QA OVRD (Item 30) allows the user to override the outcome of the QA (QA1) check and allows the receiver to be an SF candidate. QA1 data continues to be calculated, regardless of the status of the QA override. A QA OVRD does not override a receiver DG failure or a crew deselection.

QA1 P  $1\sigma$  displays the FOM for the receiver. This parameter is an indication from the receiver regarding how accurate it thinks its Nav solution is with respect to position. See [Table 1-5](#) for BFS FOM values. FOM is blank if the GPS receiver is not in NAV mode or if the GPS data is invalid.

The GPS MINUS NAV section displays the difference between the selected GPS state and the BFS Nav state in UVW coordinates (i.e., altitude ( $\Delta H$ ), downrange ( $\Delta DR$ ), and crossrange ( $\Delta CR$ )). The units are ft and ft/sec. It is an indication of where GPS thinks you are relative to where Nav thinks you are. For example: if all the GPS MINUS NAV values are positive, GPS thinks you are in front, above, and to the left of Nav.

The LAT, LON, ALT section displays GPS computed Latitude (LAT), Longitude (LON), and Altitude (ALT). Altitude is displayed in nautical miles until major mode 304 or 602; altitude is then displayed in kft. Latitude is preceded with an “N” or “S” and Longitude will be preceded with an “E” or “W” and is measured from the Greenwich meridian. It can be used to give vehicle location for bailout situations.

### 1.10.3 Differences

- a. BFS can be incorporated to Nav during ascent in addition to the entry timeframe.
- b. BFS stays in FORCE when taken to NAV and continues to update the Nav state vector with a GPS state vector. In PASS, it is a one-time update.
- c. BFS does not have Item entries on either SPEC 55 or SPEC 50 to incorporate GPS to G&C software.
- d. The ratio for GPS on SPEC 50 is always for position in BFS. In PASS, it is either velocity or position.
- e. BFS displays only QA 1. For three-string GPS operations, PASS has QA1, QA2, QA3, and QA4.

## **QUESTIONS: GPS**

1. What does GPS provide?
2. How many satellites are needed to obtain a GPS state vector?
3. True or False? When GPS is forced to Nav in PASS, it will continuously update the onboard state vector with a GPS state vector when the ratio is greater than one.
4. Can you incorporate GPS to G&C in PASS? In BFS?
5. What are the QA1, QA2, QA3, and QA4 checks?

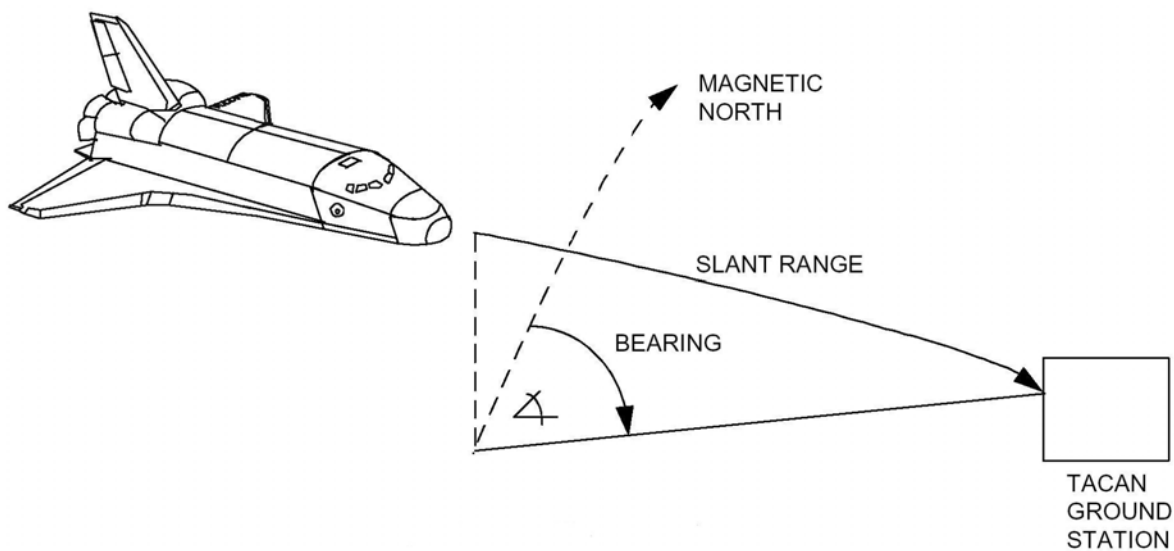
## **ANSWERS: GPS**

1. GPS provides a time and a state vector.
2. Four satellites are needed to calculate a GPS state vector.
3. False. When GPS is forced to Nav in PASS, it is a one-shot update. When GPS is forced to Nav in BFS, it is continuous.
4. GPS can be incorporated to G&C only in PASS. It is not an option in BFS.
5. QA 1 is the FOM that indicates how accurate the GPS state is. QA2 indicates how far off the GPS state is from the onboard Nav state. QA3 is the stability of the GPS state vector. QA4 is only used in three-string GPS operations; it compares the GPS units to each other.

## 2.0 TACANS

### 2.1 INTRODUCTION

The orbiter contains three airborne TACAN units operating in a triply redundant mode. The TACAN is a military L-band air navigation system that determines slant range and magnetic bearing of the orbiter with respect to a ground station (*Figure 2-1*). The TACAN range and bearing data are used to update and increase the accuracy of the navigation state vector during the entry and Terminal Area Energy Management (TAEM) flight phases, from an altitude of approximately 160,000 feet until MLS acquisition or until 1500 feet if the MLS is not available.



**Figure 2-1. TACAN output data**

### 2.2 PERFORMANCE OBJECTIVES

As a result of studying this section, the student should be able to do the following:

- a. Describe which two parameters TACAN provides to Navigation
- b. State when TACAN data is used
- c. Describe how a TACAN station operates
- d. State the source of power for the TACANS and where their cbs are located
- e. Describe the operating modes of the onboard TACAN system
- f. Describe how the crew can solve TACAN Dilemmas (DLMAs)
- g. List two basic functions performed by TACAN Redundancy Management (RM)

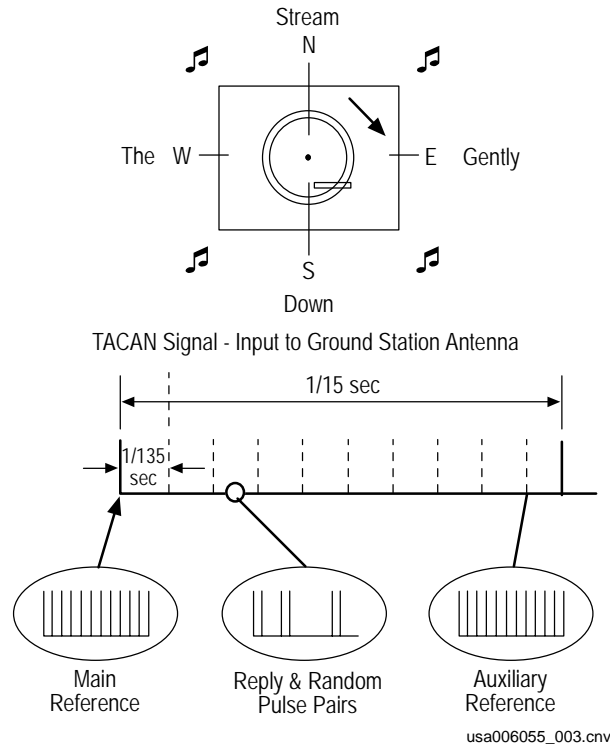
- h. List the RM limits for each TACAN parameter
- i. Describe the TACAN range and bearing two-lock requirement
- j. Describe the no COMM TACAN MGMT cue card

## **2.3 TACAN GROUND STATION HARDWARE AND OPERATION**

The ground equipment consists of a rotating antenna for transmitting bearing information and receiver-transmitter for transmitting distance (range) information. Permanent TACAN ground stations usually contain dual transmitters with automatic switchover capability.

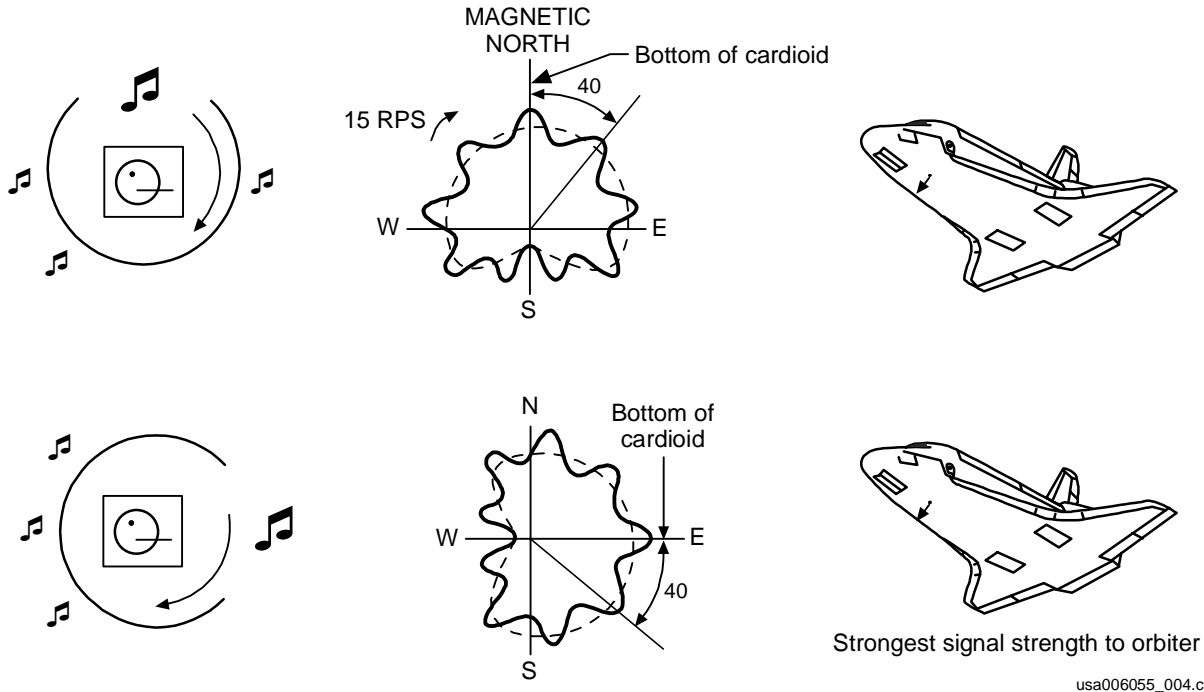
### **2.3.1 Bearing**

Bearing measurements are obtained from pulsed signals transmitted by a rotating omnidirectional antenna from the central element of the ground station. This omnidirectional signal has a fixed reference embedded within the signal that identifies the start of each cycle (east reference). This fixed reference pulse is normally referred to as the main reference bearing pulse. This omnidirectional signal may be thought of as a song on a record. This record has only one groove, so the needle of the turntable continually plays the same phrase over and over, much like a record does when it skips. The beginning of the song is the main reference bearing pulse, and the sound is omnidirectional. See [Figure 2-2](#).



**Figure 2-2. Rotating omnidirectional signal with fixed reference**

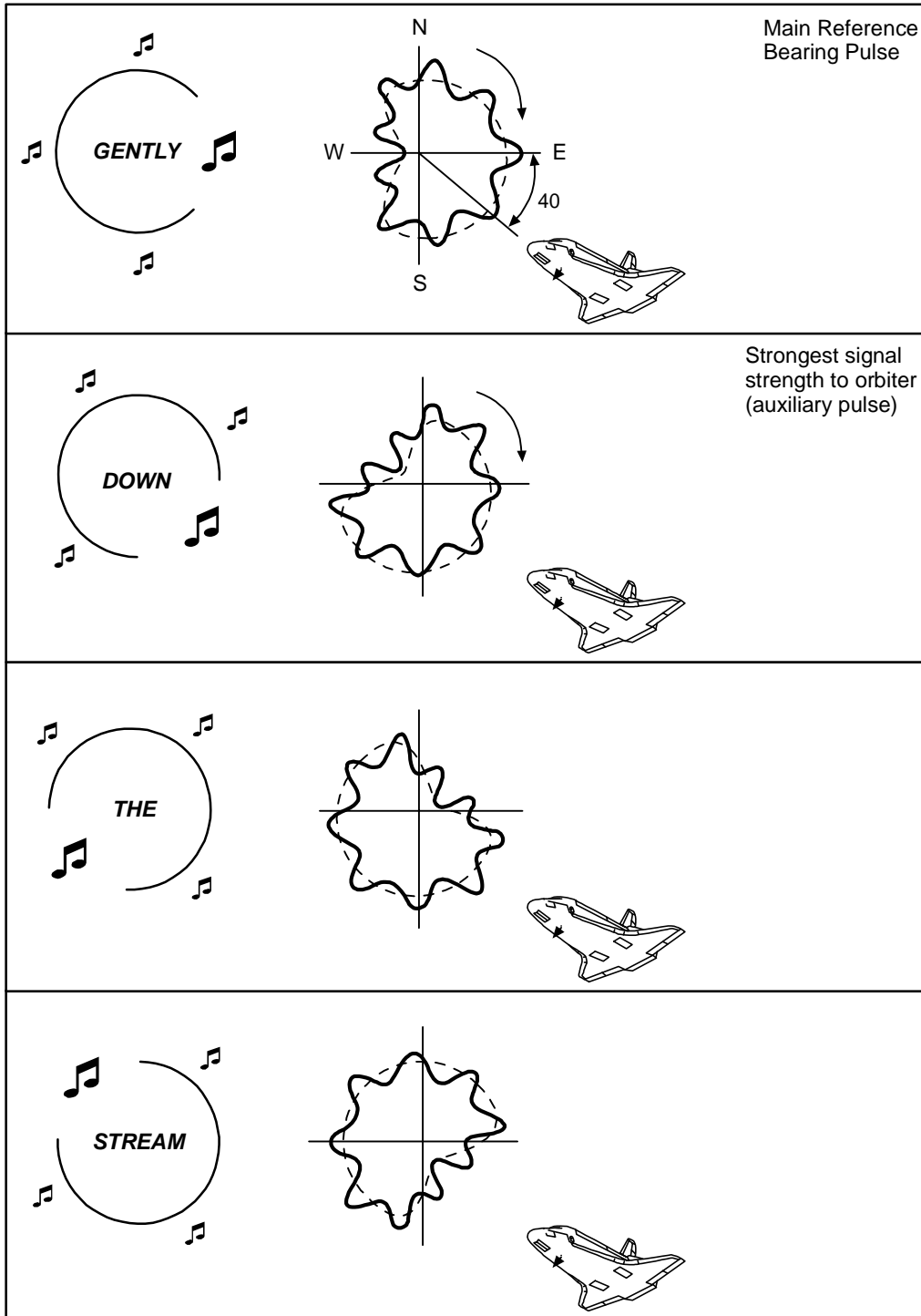
This omnidirectional signal is made into a directionally sensitive signal pattern by rotating a cylinder around the central element of the antenna at 15 revolutions per second (rps). A metal wire embedded vertically in the plastic cylinder distorts the radiated signal into a cardioid (heart-shaped) pattern. The rotation of the cylinder causes the cardioid pattern to also revolve at 15 rps. The rotating cylinder can be thought of as a sound shield (muffler) rotating around a turntable, or as a light shade rotating around a lighthouse beacon. With this mechanism, the orbiter receives a 15 cycle per second (cps) amplitude modulation signal. This means that the strength of the signal goes from maximum to minimum and back to a maximum at the rate of 15 cps. As the cardioid-forming antenna rotates around the center omnidirectional signal, the orbiter receives the strongest signal strength when the bottom of the cardioid pattern is pointing toward the orbiter and the weakest signal when the top of the cardioid is pointing toward the orbiter. See [Figure 2-3](#).



**Figure 2-3. Rotating antenna makes signal directionally sensitive**

Another larger cylinder, with 9 wires in it, is mounted around the central element and also rotates at 15 rps. This is the fine antenna that superimposes nine lobes on the previously formed cardioid pattern. This forms a 135-cps signal (9 lobes or cycles x 15 rps).

To determine the orbiter's position in bearing from the station, a phase angle must be electronically measured from a fixed reference. This fixed reference pulse, normally referred to as the main reference bearing pulse, is used to identify the start of each cycle that points in the east direction. One main reference pulse occurs with each revolution of the antenna. In addition to the main reference pulse, eight auxiliary reference pulses also occur during one revolution of the ground antenna. Therefore, a reference pulse occurs each 40 degrees of antenna rotation (360 deg/9 pulses). See [Figure 2-4](#).



usa006055\_035.cnv

**Figure 2-4. Bearing determination**

Bearing is determined by electronically measuring the time lapse between the start of the main reference pulse (east reference) and the strongest signal received from an auxiliary reference pulse (recall that the auxiliary pulse that is pointing in the direction of the orbiter will give the strongest signal strength). This determines the orbiter's bearing



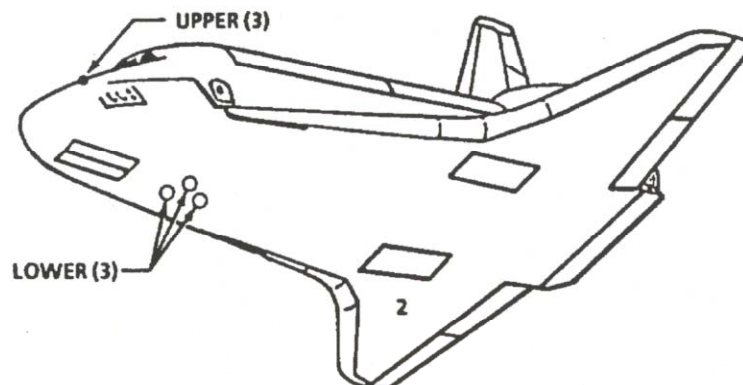
from the station within a 40° sector. Then, the time lapse between the measured amplitude of auxiliary reference pulse and the maximum amplitude of the auxiliary (135 cps) signal is used to determine the orbiter's position within the 40° sector.

### 2.3.2 Range

Range (RNG) or distance is determined by measuring the time difference between transmission of pulses from the airborne TACAN unit to the ground station and reception of the reply pulses from the ground station back to the airborne unit. The orbiter transmitter starts the process by sending out the distance interrogation pulse signals. Reception of these signals by the ground station receiver triggers its transmitter to send out the distance reply pulse signals. Since a large number of aircraft could be interrogating the same TACAN station as the orbiter, the airborne TACAN unit must sort out only the pulses that are replies to its own interrogations. Interrogation pulses are transmitted on an irregular, random basis by the airborne TACAN unit, which then "searches" for replies that are synchronized to its own interrogations.

## 2.4 ORBITER-RELATED HARDWARE

Onboard the orbiter is the receiver/transmitter portion of the TACAN system. Three identical units are located in the forward avionics bays. Each TACAN unit is equipped with two antennas located on the upper and lower side of the orbiter nose area (*Figure 2-5*). The TACAN units on the shuttle are sometimes referred to as Collins. Previously, there was a mixed fleet of ac- and dc-powered TACANS. The ac-powered TACANS were called Gould. Each unit requires 28 volts dc power, which is supplied through Main A O14, Main B O15, and Main C O16 for TACAN 1, 2, and 3, respectively. Essential bus power from 1BC, 2CA, and 3AB is also utilized by TACANS 1, 2, and 3, respectively, to power the auto self-test discrete that enables the TACANS to do an automatic self-test when commanded by the GPCs.



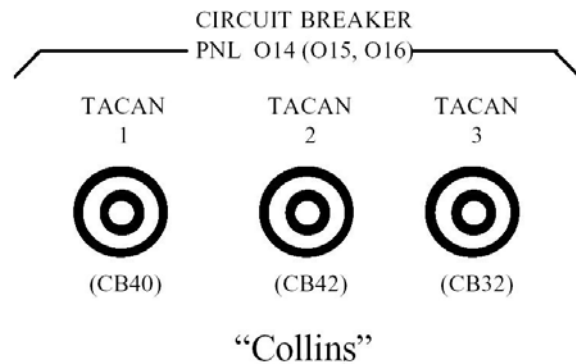
**Figure 2-5. Orbiter TACAN antenna locations**

Range and bearing data for each TACAN is transmitted to and from the GPCs over the Flight-Critical (FC) data buses to the Flight Forward (FF) MDMs. TACAN 1, 2, and 3 data are routed through FF MDMs 1, 2, and 3, respectively. Data flow between the TACAN and the MDM is controlled by a special dedicated TACAN/Radar Altimeter Input/Output Module (TAC/RA IOM) in the MDM. (This scheme was implemented to accommodate off-the-shelf TACAN and RA equipment.) The module interfaces with the TACAN control panel, the TACAN, and the RA. If this module fails, a BCE STRG X TAC fault message is annunciated. This inhibits TACAN and RA data inputs from that MDM to the GPCs.

A useful point to remember is that because the TACANs and RAs are connected to this special IOM in the MDM, no I/O RESET is needed when these units are powered ON. The GPCs automatically upmode the TACANs and RAs when power is seen. Also, when these units are powered OFF, no message is annunciated. The only cause of the BCE STRG X TAC fault message is when the special IOM fails in the MDM. TACANs and RAs are the only LRUs that operate in this manner.

## 2.5 TACAN CREW CONTROLS

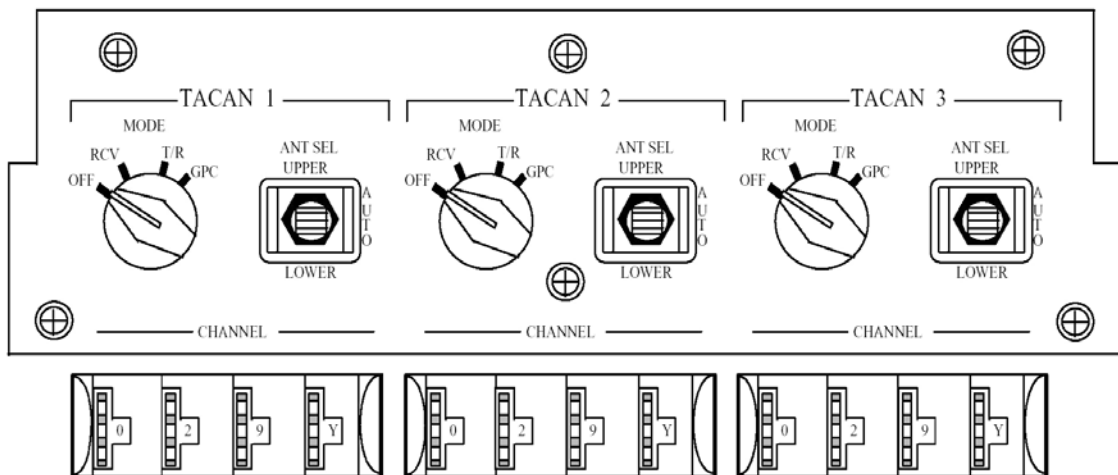
The onboard TACANs receive power from MNA O14 for TACAN 1, MNB O15 for TACAN 2, and MNC O16 for TACAN 3 through circuit breakers on Panels O14, O15, or O16 (see [Figure 2-6](#)). When the cbs are closed, power is applied to the TACANs control head switches on Panel O7.



**Figure 2-6. TACAN DC power on Panels O14, O15, and O16**

Ultimate control of each TACAN is through its associated control panel ([Figure 2-7](#)). Three identical, yet independent, control heads are mounted side by side. Each controls the MODE, CHANNEL, and ANTENNA of its respective TACAN. Mounted on each control head is a four-position rotary MODE switch, which controls the operational mode of the TACAN. The four positions are:

- a. OFF – No power to TACAN.
- b. RCV (Receive) – Only bearing data processed by the hardware. (This mode is not operationally used in orbiter operations.) Channel selection is manually accomplished by selecting a channel on the thumbwheels.
- c. T/R (Transmit/Receive) – Both bearing and range are processed in this mode. Channel selection is manually accomplished by selecting a channel on the thumbwheels.
- d. GPC – Both bearing and range are processed in this mode. Channel selection is controlled automatically by Guidance, Navigation, and Control (GNC) software. GPC-commanded self-test is supported in this mode for PASS only.



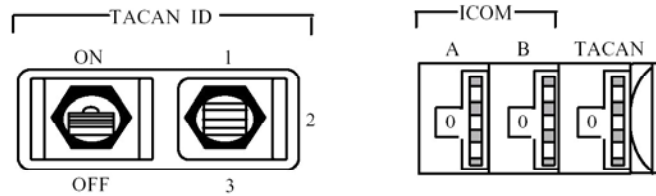
**Figure 2-7. TACAN system controls**

Each control head also has a set of three thumbwheel switches or pushbuttons for selecting TACAN CHANNEL, numbers 1 through 126. A fourth thumbwheel determines the mode of the ground station (X or Y). This essentially doubles the available frequencies that can be accessed from 126 to 252. The channel is manually selectable from the control head when in the T/R or RCV mode or automatically selectable through the GNC software when in the GPC mode.

Control of the TACAN upper and lower antennas is through the ANT SEL (Antenna Select) switch mounted on each control head. This is a three-position switch.

- a. UPPER – Upper antenna is selected.
- b. AUTO – The antennas are controlled by the GPCs, allowing it to automatically select the best antenna based on signal strength. This function is independent of the TACAN mode switch.
- c. LOWER – Lower antenna is selected.

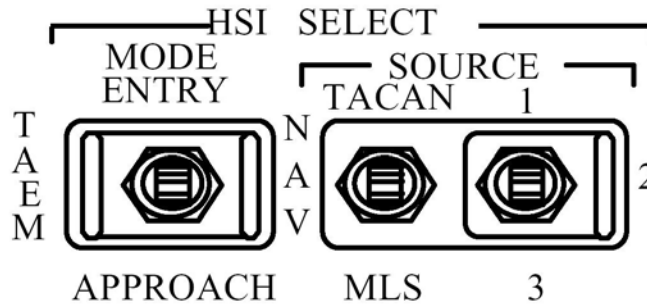
The TACAN ID switches are found on Panels O5 and O9 for the commander (CDR) and pilot, respectively (*Figure 2-8*). By selecting the TACAN ID switch to ON, any one of the three TACANs can be monitored to verify proper station acquisition. The TACAN station produces a tone that consists of a three-letter Morse Code signal that identifies the station. Also found on Panel O5/O9 is the TACAN volume thumbwheel, which controls the volume of the audio tone. In practice, the crew does not use this feature for a nominal landing; however, it could be necessary during a contingency deorbit.



**Figure 2-8. TACAN ID controls on Panels O5 and O9**

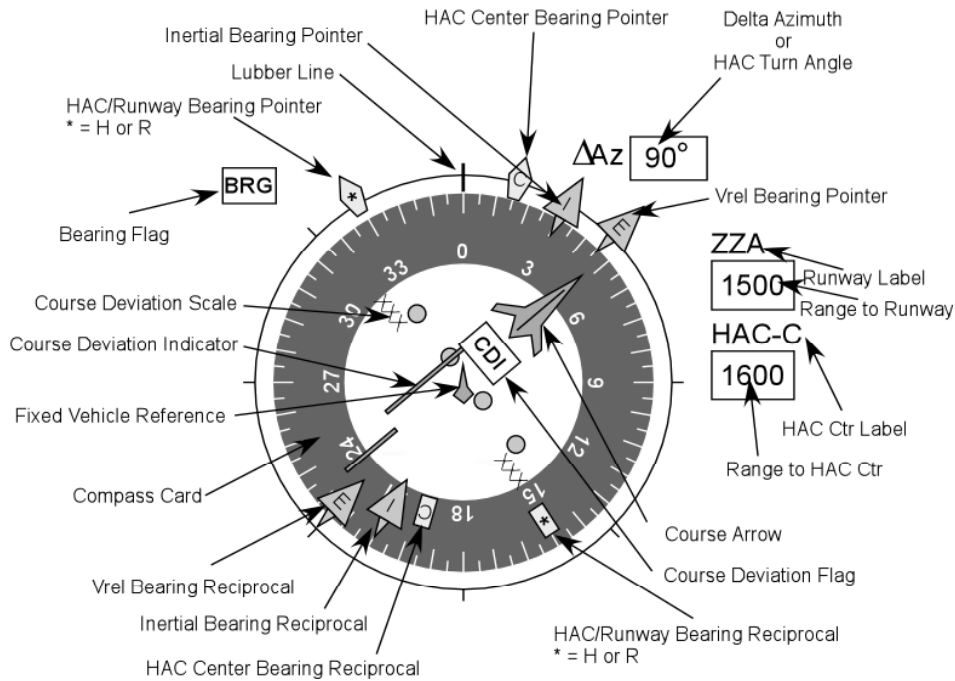
The Horizontal Situation Indicator (HSI) SELECT switches, which are located on Panels F6 and F8 (*Figure 2-9*), control the data input to the HSIs on the Multifunction Electronic Display System (MEDS) Ascent/Entry Primary Flight Display (A/E PFD). The MODE switch provides a signal to the GPCs that selects data to display for the Entry, TAEM, or Approach and Land phase of flight. (If the Entry mode is selected, the HSI automatically displays the data for Entry, TAEM, or Approach and Land.) The HSI displays area navigation data calculated by using raw TACAN data from one of the three onboard TACAN units, as selected on the adjacent toggle switch. When the SOURCE switch is set to NAV, the HSI displays data from the GPC navigation state vector.

Each TACAN unit can be compared to Nav, using the HSI SOURCE switches. This is one available tool that the crew can use to solve TACAN dilemmas. The crew can also select TACAN data on the HSI and use it for a guidance source (cues for manual flying) when they have determined that the onboard GPC navigation state vector is bad and the orbiter must be flown manually.



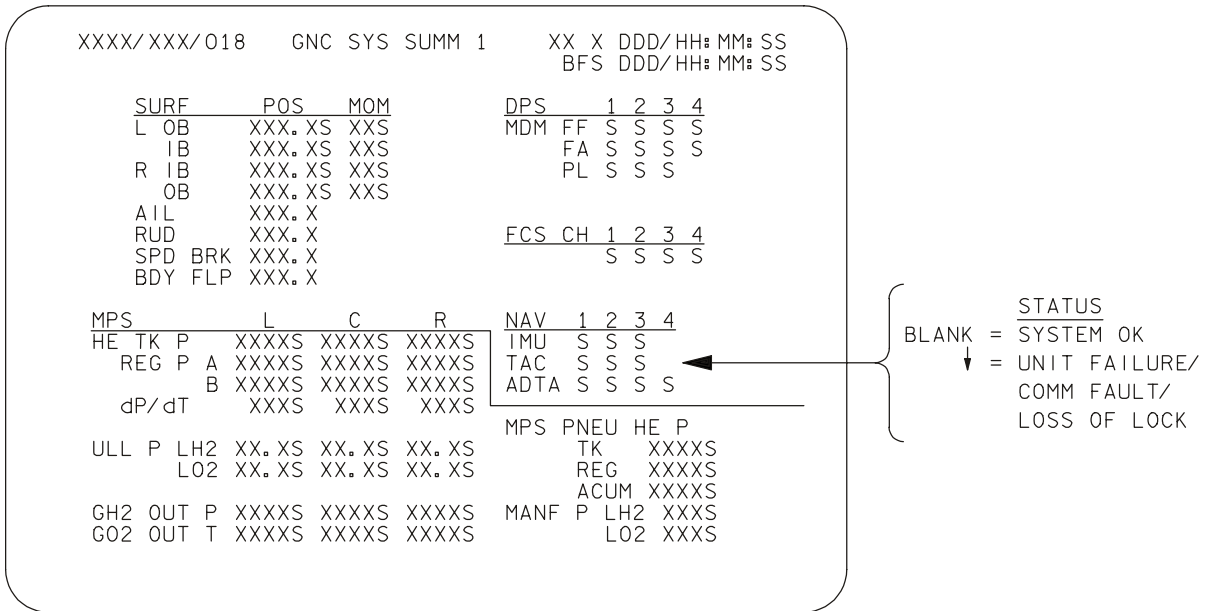
**Figure 2-9. HSI switch location on Panels F6 and F8**

Raw TACAN data or TACAN-derived GPC navigation is presented to the crew on the HSI (depending on the position of the source switch). The Course Deviation Indicator (CDI) is displaced from the center of the HSI by TACAN bearing (azimuth) data. A displacement of the bar toward the dots on the right tells crewmen to fly toward the right. Corrections are always made by flying in the direction of displacement. Range information is displayed in the upper left and right corners. This range is the distance to the primary and secondary waypoints (guidance points along the entry trajectory), respectively, (see [Figure 2-10](#)).



**Figure 2-10. MEDS HSI**





006055002. CRT: 2

Figure 2-12. BFS GNC SYS SUMM 1 display

### 2.6.2 SPEC 50 - Horizontal Situation Display

The HSD (SPEC 50) allows control and assessment of the navigation filter performance, as well as the three TACANs (Figure 2-13 and Figure 2-14). A “TAC AZ” and a “TAC RNG” row are identified on the bottom left of SPEC 50 and extend across the display.

Note: The BEARING is incorrectly labeled as AZIMUTH (AZ) and, to prevent confusion, “Azimuth” will be used to refer to Bearing.

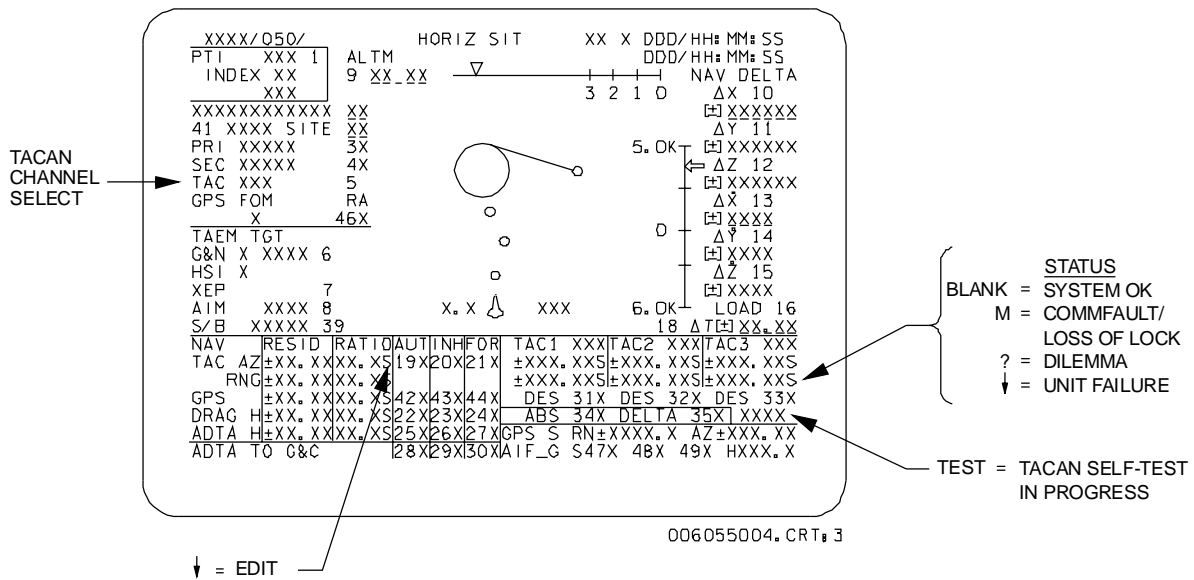


Figure 2-13. PASS GNC HORIZ SIT display

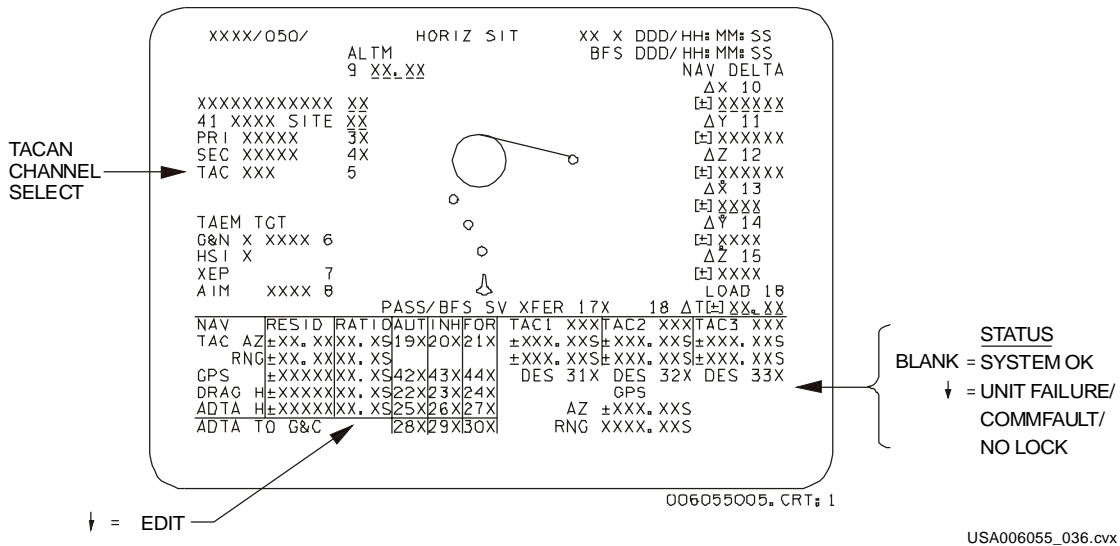


Figure 2-14. BFS GNC HORIZ SIT display

The TACAN data presented in the lower right corner of the display represents actual slant range and magnetic bearing of each airborne unit to the TACAN ground station if ABS (ITEM 34) is selected. If DELTA (ITEM 35) is selected, the difference between the airborne TACAN-measured data and the navigation-derived data is displayed (BFS supports only ABS mode). The bearing or azimuth parameters are in degrees. The range parameters are in nautical miles. The display is initialized with DELTA selected.

The TACAN ground station channel that TACANs 1, 2, and 3 are locked onto is also displayed in the lower right corner. A "-" to the left of the channel represents "Y." A blank will be to the left of the channel to represent "X."



A status to the right of the values is provided for a Bearing (AZ) and Range (RNG) for each TACAN. The same status legend used on GNC SYS SUMM 1 applies.

ITEMs 31-33 allow a failed TACAN to be deselected/reselected. BFS listens for the ITEMs 31-33 made on PASS. It executes them when it hears them as if they were typed to the BFS. Therefore, when you deselect a TACAN in PASS, it is also deselected in BFS (if previously selected).

The word "TEST" is displayed if the self-test is being conducted (PASS only).

The navigation filter displays and controls for TACANs AZ and RNG are provided in the lower left of SPEC 50. For each parameter, the output from its SF minus the composite Nav state vector estimate of that data forms the residual (RESID). The ratio (RATIO) of actual RESID to the maximum allowable RESID is displayed in the RATIO column.

ITEM 19 (AUT) is used to allow navigation to automatically select data to be used by the Kalman Filter if it passes the Ratio Edit Test. If the RATIO is greater than one for three consecutive Nav cycles, the Ratio Edit Test fails. A status column to the right of the RATIO column contains a down arrow when the parameter has failed the Ratio Edit Test. ITEM 20 (INH) inhibits the incorporation of TACAN data into the state vector (the display is initialized in this position). ITEM 21 (Force (FOR)) bypasses the Ratio Edit Test and forces the Nav filter to use TACAN data, regardless of the Ratio.

Note: If TACAN data is being FORCED, MLS data is not incorporated into Nav.  
TACANs must be in INH or AUT for MLS data to be incorporated into Nav (PASS only).

SPEC 50 also provides the capability to select either of two TACAN stations associated with a selected landing area by toggling ITEM 5. When a landing site is selected through ITEM 41, the primary TACAN station is automatically selected. The selected station ID is displayed next to ITEM 5. Selection of the primary or secondary runway at a landing site (ITEMs 3 and 4) does not affect the selected TACAN station. The TACAN mode switch on Panel O7 must be in the GPC position in order for ITEM 5 to actually change the station. If the mode switch is in any other position, the airborne TACAN unit will be tuned to the channel selected on the TACAN channel thumbwheels, regardless of the station or channel selected by ITEM 5 on SPEC 50.

### 2.6.3 SPEC 40 - Sensor Test Display

The Sensor Test display (*Figure 2-15*), which is available in OPS 8 and can be called up through SPEC 40 PRO, provides a means of initiating, monitoring, and terminating the self-test of the TACANs (BFS does not support OPS 8). It also provides control of the SF.

Execution of a DES (ITEM 4, 5, or 6) changes the status of that TACAN's availability to the SF. An "\*" appears next to the Item number if the corresponding unit is deselected as a candidate. The SF configuration from this display is carried over into OPS 3.

RNG in nautical miles and bearing (AZ) in degrees are displayed for each TACAN. These values are compared to the self-test limits. A status indicator is displayed beside each test parameter indicating the results of the tolerance check. The self-test controls are shown at the bottom of the display. Execution of ITEM 13 starts the self-test on all the displayed sensors. Execution of ITEM 14 stops the self-tests. An "\*" appears next to Items 13 or 14 to indicate, respectively, test underway or test stopped. ITEMS 13 and 14 are initialized blank.

```

XXXX/040/          SENSOR TEST   XX X DDD/HH: MM: SS
                                DDD/HH: MM: SS

  DES STAT  RNG    AZ    EL
MLS 1  1X XXXX XX.XS ±X.XXS X.XXS
     2  2X XXXX XX.XS ±X.XXS X.XXS
     3  3X XXXX XX.XS ±X.XXS X.XXS

  DES STAT  RNG    AZ
TAC 1  4X XXXX X.XS XXX.XXS
     2  5X XXXX X.XS XXX.XXS
     3  6X XXXX X.XS XXX.XXS

  DES STAT  ALT
RA  1  7X XXXX XXXXS
     2  8X XXXX XXXXS

  DES          Y          Z
AA  1  9X      ±XX.XS ±XX.XS
     2 10X      ±XX.XS ±XX.XS
     3 11X      ±XX.XS ±XX.XS
     4 12X      ±XX.XS ±XX.XS

                                START 13X STOP 14X

```

TEST LIMITS ARE AS FOLLOWS:  
 RANGE      0±0.5 n.mi.  
 BEARING    180°±2.5°

006055003. CRT: 3

**Figure 2-15. Sensor Test SPEC 40**

## 2.6.4 SPEC 101 - Sensor Self-Test Display

The Sensor Self-Test display is available in OPS 9 through SPEC 101 PRO for preflight and postlanding checkout of the TACANs ([Figure 2-16](#)). It is the ground test equivalent of the on-orbit Sensor Test (SPEC 40). BFS does not support OPS 9.

```

XXXX/101/      SENSOR SELF-TEST  XX X DDD/HH: MM: SS
                DDD/HH: MM: SS

  ENA STAT  RNG   AZ   EL
M1  1X XXXX XX.XS ±X.XXS X.XXS
L2  2X XXXX XX.XS ±X.XXS X.XXS
S3  3X XXXX XX.XS ±X.XXS X.XXS

  ENA STAT  RNG   AZ
T1  4X XXXX X.XS  XXX.XXS
A2  5X XXXX X.XS  XXX.XXS
C3  6X XXXX X.XS  XXX.XXS

  ENA STAT  ALT
R1  7X XXXX XXXXS
A2  8X XXXX XXXXS

  ENA          Y      Z
A1  9X        ±XX.XS ±XX.XS
A2 10X        ±XX.XS ±XX.XS
3  11X        ±XX.XS ±XX.XS
4  12X        ±XX.XS ±XX.XS

TEST CONTROL:
START      13X
AUTO SEQ   14X
TERM       15X
INH ALL    16X

```

006055006. CRT: 1

**Figure 2-16. Sensor Self-Test SPEC 101**

## 2.6.5 GPC Fault Messages

Five possible TACAN-related fault messages can be generated by the GPCs and displayed.

- “RM FAIL TAC” - Range or bearing parameter failure based upon two out of three comparison at the three-level for PASS only (see RM for more details).
- ”RM DLMA TAC” - Data from two TACANs differ beyond the Fault Detection, Identification, and Reconfiguration (FDIR) threshold and RM is unable to resolve the discrepancy. Automatic self-test at the two-level tries to resolve a dilemma if both TACAN units have the GPC mode selected (see RM for more details). This applies to PASS only.

- "NAV EDIT TAC" - Annunciated below 140 kft when TACAN data is not incorporated into Nav after 7 Nav cycles (approx. 30 sec.). This applies to PASS only.
- "NAV EDIT" - TACAN range or bearing ratio >1 for three consecutive Nav cycles (BFS only).
- "BCE STRG X TAC" - Within the MDM is a special Input/Output Module or "card" that is dedicated to RAs and TACANs. If this module fails, a BCE STRG X TAC fault message is annunciated. This inhibits TACAN and RA data inputs from that MDM to the GPCs.  
 Note: There is no commfault annunciation for TACANs other than "M" in PASS or a down arrow in BFS on GNC SYS SUMM 1 and SPEC 50 unless the card is lost. Also, no I/O reset is required when powered ON.

## 2.7 TACAN SYSTEM SOFTWARE

The TACAN Subsystem Operating Program (SOP) is one of many program modules contained in the GPC main memory. It is active during entry Major Mode (MM) 304-305 and during Return-to-Launch Site (RTL) aborts in MM 602-603 in both the PASS and BFS. The TACAN SOP contains the software associated with TACAN range and bearing data processing, auto channel command processing, upper/lower antenna selection, and RM processing.

Slant range measurements are obtained through pulsed transmissions from both the TACAN and the ground station. The onboard unit starts the process by transmitting a signal to the ground station. The station detects the signals and transmits a signal back to the onboard TACAN unit. Range is calculated from the round-trip travel time of the signal between the TACAN and the ground station.

Bearing measurements are obtained from pulsed signals transmitted by a rotating directional antenna system at the ground station. This rotating antenna system produces a pattern of pulses that goes from a maximum to a minimum and back to a maximum at a fixed rate (remember the lighthouse beacon and light shade analogy). Embedded within this signal pattern is a main reference pulse to identify the start of each cycle, which is the east reference. Eight auxiliary reference pulses spaced 40° apart are also presented in the signal pattern. Bearing is determined by electronically measuring the time between the main reference pulse (east reference) and the strongest auxiliary reference pulse (auxiliary pulse that is pointing in the direction of the orbiter will give the strongest signal strength).

A table of available landing sites and their associated TACAN stations is maintained by the GPC in the OPS 1/6-ascent/RTL and OPS 3-entry software. This table is formatted based on an area concept. An area is defined as any potential landing site.

Associated with each are two runways (primary and secondary), two MLS stations (if they exist), and two TACAN stations. *Figure 2-17* shows a typical list of available landing areas and their associated primary and secondary channel IDs from the entry checklist. Mission Control Center (MCC) can uplink a new landing site, if needed.

If the antenna switch on Panel O7 is manually placed in either UPPER or LOWER, the corresponding antenna is selected. If the switch is in AUTO, the GPC controls antenna selection.

STS-114  
LANDING SITE TABLE  
(OPS 1/6/3)  
(50° to 53.5° INCLINATION)

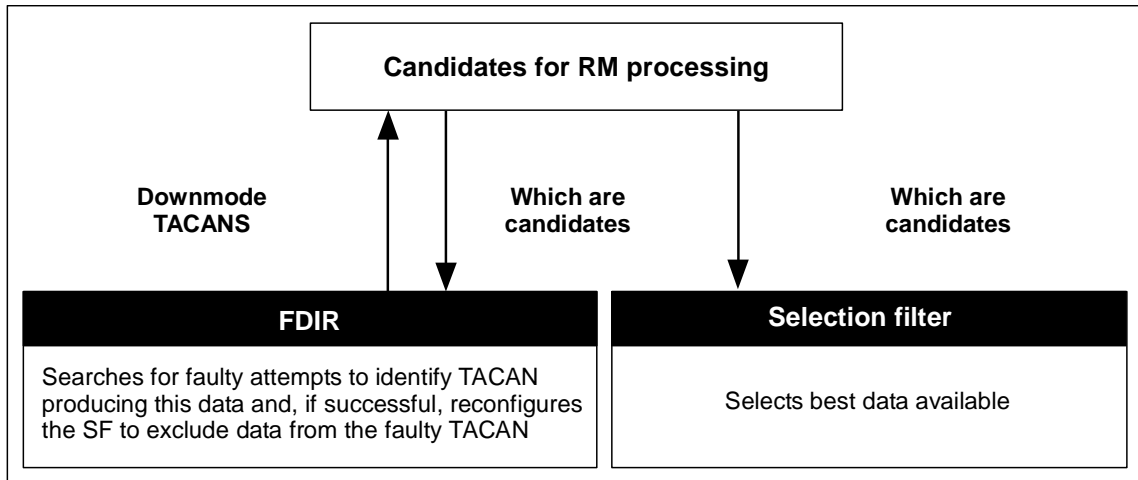
| S<br>I<br>T<br>E | LOCATION                 | RWY                | TACANS      |               | MLS<br>CH | LG             |
|------------------|--------------------------|--------------------|-------------|---------------|-----------|----------------|
|                  |                          |                    |             | ITEM 5        |           |                |
| 1                | KSC                      | KSC 15<br>KSC 33   | TTS 59Y     | OMN 73        | 8<br>6    | 15000<br>15000 |
| 2                | BEN GUERIR               | BEN 36<br>BEN 18   | ◆BEN 108    | CBA 116 (DME) | ◆6<br>-   | 13720<br>12720 |
| 3                | MORON AB                 | MRN 20<br>MRN 02   | MRN 100     | AOG 23        | ◆6<br>-   | 11929<br>11729 |
| 4                | ZARAGOZA                 | ZZA 30L<br>ZZA 12R | ZZA 64      | ZZA 77 (DME)  | ◆6<br>-   | 12397<br>12197 |
| 5                | CHERRY POINT             | NKT 32L<br>NKT 23R | NKT 75      | EWN 83 (DME)  | -<br>-    | 8402<br>8482   |
| 6                | OCEANA NAS<br>WILMINGTON | NTU 23L<br>ILM 06  | NGU 48<br>- | -<br>ILM 117  | -<br>-    | 11997<br>8000  |

**Figure 2-17. Landing site data chart from entry checklist**

Each TACAN unit has an internal self-test feature whereby the range and bearing circuits can be exercised independently (PASS only). However, an external self-test command is required to initiate the test. This command may be generated automatically by TACAN RM in response to data miscomparisons at the two-level in OPS 3 and 6 or manually from the keyboard in OPS 8 and 9. In both cases, the mode switches on Panel O7 must be in GPC to execute the self-test, and the essential bus for each TACAN unit's self-test cannot be down.

## 2.8 REDUNDANCY MANAGEMENT

TACAN RM performs two basic functions (*Figure 2-18*). An SF selects a single range and bearing from multiple data sources (or candidates). Range and bearing failures are then declared failed through FDIR. The SF and FDIR run in PASS software in both OPS 3 and 6. BFS software has an SF only in OPS 3 and 6; no FDIR is available. TACAN RM information is displayed on the GNC SYSTEM SUMMARY 1 display, the GNC Horizontal Situation display (SPEC 50), and on the HSI on the MEDS flight instrument display in both PASS and BFS.



**Figure 2-18. Redundancy management processing**

SF and FDIR are processed on a parameter-by-parameter basis. Therefore, the status of the range parameter does not affect the status of the bearing parameter.

The first step in TACAN RM is to determine which TACANS are candidates for selection by the SF. Candidacy is determined by the following criteria:

1. Not powered OFF.
2. Not manually deselected.
3. Not currently failed (PASS only).
4. Not commfaulted.
5. Not involved in self-test at two-level (PASS only).
6. Not in the bearing cone of confusion.
7. Not experiencing multiple of 40° bearing glitches at the three-level.
8. Not in a two-lock requirement scenario, PASS only.

**A brief description of each follows:**

1. Not powered OFF

The TACAN unit must be powered ON before it can be considered a Candidate for RM processing. All three TACANS are powered ON at deorbit minus 2 hours and 20 minutes while in the Deorbit Prep Checklist.

Note: TACANS do not require an I/O Reset to establish I/O transactions.

2. Not manually deselected

The TACAN unit must be selected (not deselected) to be considered available. Since manual selection and deselection are on a unit basis, both the range and the bearing will be affected.

3. Not currently failed (PASS only)

A TACAN parameter is considered available if it has not been declared failed by FDIR. Failure on one parameter does not affect the availability of the other parameter associated with that unit. FDIR exists only in PASS for TACANs, so TACANs cannot be declared failed by RM in BFS.

4. Not commfaulted

On any given cycle, data availability is dependent upon a valid I/O transaction. If the data is determined to be unavailable (commfaulted), the entire TACAN (range and bearing) is bypassed.

5. Not involved in self-test at the two-level (PASS only)

TACAN self-test is controlled by the TACAN SOP and commanded by TACAN FDIR software to assist in resolving a dilemma situation. Self-test is performed on both the range and bearing parameters, regardless of which one is in dilemma. One parameter must be above RM limits before FDIR will command a self-test.

RM limits:       Range – 3006 ft  
                  Bearing – 6°

The TACAN SOP sends self-test commands to each unit separately. The TACAN units process only self-test data while in self-test (i.e., the SF cannot use the TACANs as candidates). Each TACAN then receives a predefined range and bearing signal of 0.0 nautical miles and 180°, respectively. After about 19 seconds, the TACAN SOP checks the output range and bearing signals against the high and low limits listed below.

|         | High      | Low       |
|---------|-----------|-----------|
| Range   | 0.5 n.mi. | 0.0 n.mi. |
| Bearing | 182.5°    | 177.5°    |

A range or bearing value outside these limits is interpreted as a failure, and the respective range or bearing fail flag is set True. In addition, the SOP checks the status of the Test Status Monitor (TSM) hardware discrettes for each TACAN. The TSM reflects the results of an internal hardware test performed in much the same way as the previous test. The TSM limits are listed below.

|         | High      | Low       |
|---------|-----------|-----------|
| Range   | 0.2 n.mi. | 0.0 n.mi. |
| Bearing | 182.0°    | 178.0°    |

It always holds true that if the software limit check fails for a given TACAN parameter, the TSM hardware discrete will also indicate failed because the hardware limits are tighter than the software limits. However, if the signal is biased between the two limits (i.e., 0.3 n.mi.), only the TSM hardware discrete will indicate failed.

The SOP then tallies the fail votes and attempts to declare a failure. If only one TACAN parameter fails the limit test (either the software limit or the TSM hardware limit), it is declared failed and self-test is exited. If self-test determines a failure of the range and/or bearing parameter on both TACANs or no parameter is determined to be failed on either TACAN, the test is exited without resolving the dilemma (see FDIR section for more information on unresolved self-test). If a failure was identified, it is annunciated on the DPS display. The candidates for SF processing are then updated to reflect the failed parameter.

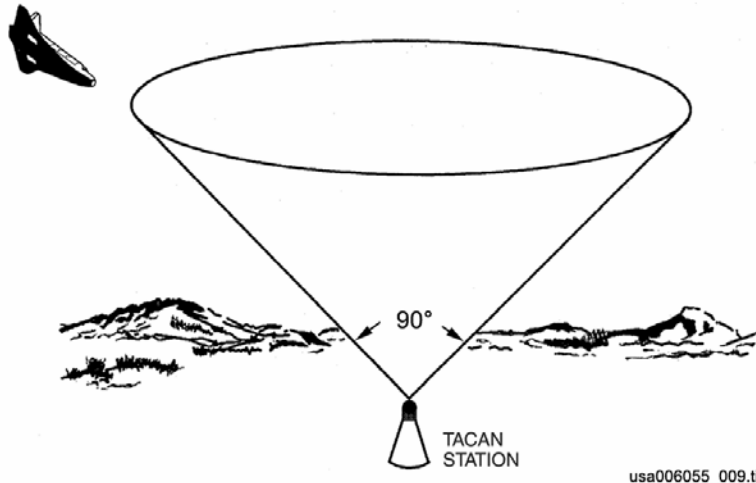
Note: The TACAN SOP does not place either of the two TACANs into self-test unless both units in dilemma are in the GPC MODE on Panel O7 and neither unit has lost its self-test capability because of an essential bus failure. If this requirement is not satisfied, the two LRUs remain in a dilemma situation and require crew intervention.

Note: No self-test capability exists in BFS. However, BFS responds to the situation when PASS is performing a TACAN self-test. BFS stops using TACAN data until PASS self-test is completed (ratio/residuals blank and down arrows appear next to the bearing and range on BFS SPEC 50).

## 6. Not in the bearing cone of confusion

Because of the horizontal directivity of the ground station antenna radiation pattern, a volume of weak and/or poor radio frequency energy is created. Thus, bearing data will be erroneous. The volume has the shape of an inverted cone in which the included angle varies from 60° to 120°, typically 110°. It is usually termed the "Bearing Cone of Confusion" ([Figure 2-19](#)).





**Figure 2-19. Bearing cone of confusion**

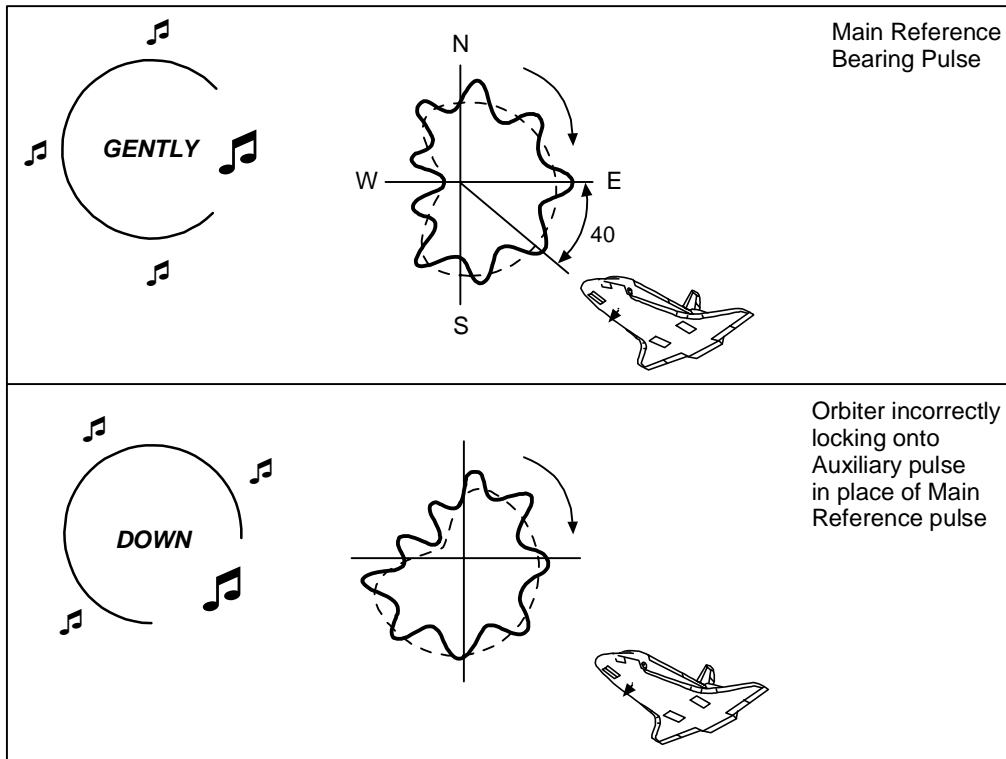
The GPCs compare the elevation difference between the orbiter position vector and the TACAN position vector. This is compared against the threshold elevation limit to determine if the orbiter is in the bearing cone of confusion. If within the calculated bearing cone of confusion, the TACAN bearing is not a Candidate for RM processing. The ratio/residuals for bearing will blank on SPEC 50.

Since the bearing cone of confusion is determined from the Nav position vector, a bad Nav state onboard the orbiter will cause the bearing cone of confusion calculation to be in error (i.e., bearing data may be available when it is in error and not available when it should be).

7. Not experiencing multiple of 40° bearing glitches at the three-level

The onboard TACAN unit, nominally, will lock on to the main bearing reference pulse (east reference pulse) from the ground station at 90°. With a weak onboard TACAN receiver, the TACAN receiver may miss the main reference pulse and lock on to one of the auxiliary positions in place of the main reference pulse (giving the TACANs an incorrect east reference). When this occurs, bearing will be biased by 40°, or what is called a “40-Degree Bearing Glitch.” This condition usually does not last more than a few seconds at a time. Collins TACANs are not susceptible to 40° bearing glitches like the Gould TACANs were.

If the 40° bearing glitches occur at the three-level, RM recognizes this type of bearing anomaly and handles these biases differently than other types of bearing biases. No annunciation occurs and FDIR does not declare the bearing parameter failed. Bearing from those TACANs are not used as a candidate for the SF for the duration of the glitch. At the one and two-level, normal FDIR/SF processing occurs for these glitches/biases (i.e., at the two-level, a miscompare will cause a dilemma; at the one-level, the data will be used). See [Figure 2-20](#).



usa006055\_010.crv

**Figure 2-20. Forty-degree bearing glitches**

8. Not in a two-lock requirement scenario, PASS only

The TACAN provides a status signal that indicates if it has locked onto a ground station. The SF treats a unit NOT locked on as a POTENTIAL candidate. The TACAN SOP for PASS software has a two-lock requirement for both range and bearing when two or more TACAN parameters are candidates for the SF. The two-lock Range requirement goes away about 30 seconds after processing by Nav; i.e., TACANs have been placed in AUTO or FORCE on SPEC 50 and have been that way for more than 30 seconds. The two-lock bearing requirement never goes away.

Note: If at any time the crew performs a zero delta state update on SPEC 50, the two-lock RNG requirement is reinstated. Also, if GPS is in AUTO, the range two-lock requirement goes away.

For example: TACAN 1 is deselected, TACAN 2 does not lock on in range or bearing, and TACAN 3 has no problems. Neither two-lock requirement is met. No ratios/residuals for either parameter will be displayed on SPEC 50. If, however, TACAN 2 locks on in range and bearing, both two-lock requirements would be met and Nav can start processing TACAN data upon taking TACANs to AUTO on SPEC 50 (ITEM 19). If TACAN 2 lost lock 30 sec after being taken to AUTO, the bearing two-lock requirement would not be met and ratios/residuals for bearing would blank. The range two-lock requirement would be met. If the crew executed a Zero Delta

State Update on SPEC 50, the two-lock range requirement would be reinstated, and the range ratios/residuals would also blank.

If TACAN 1 is deselected, TACAN 2 bearing fails, and TACAN 3 has no problems, only one bearing parameter is available (TACAN 3 bearing). This does not violate the two-lock bearing requirement, because only one bearing is available as a candidate. The two-lock requirement applies only when two POTENTIAL candidates are available. If TACAN 1 is deselected and the bearing for TACAN 2 never locks on, TACAN 2 would have to be deselected in order to meet the bearing two-lock requirement.

There is no two-lock requirement in BFS for TACANS. The only conditions in BFS are

- a. At least two TACANs tuned to the same station as seen on SPEC 50
- b. One TACAN locked on

## **2.9 SELECTION FILTER (SF)**

### **2.9.1 Three-Level**

Selection filtering uses a Midvalue Select (MVS) scheme (both for PASS and BFS) to provide a single range and bearing input when three valid inputs are available. This is accomplished by computing the difference between each TACAN. This results in three error values: 1-2, 2-3, and 3-1. The data from the TACAN that is common to the two smallest differences is selected for output.

### **2.9.2 Two-Level**

At the two-level, a data output value is provided that is the average of the two available inputs for the PASS TACAN SF. The BFS prime-selects the lowest-numbered TACAN unit at the two-level.

### **2.9.3 One-Level**

At the one-level, the data from the only available TACAN is used.

### **2.9.4 Zero-Level**

The no-available-sensor level does not provide a new data output value. The output value remains unchanged from its previous valid value. The data is labeled invalid. Therefore, the data is not used.

### **2.9.5 “Data Good” (DG) Protection**

The SF provides transient protection through a DG flag whenever out-of-tolerance range or bearing data is detected. The DG flag is always set True for the three-level

and one-level. It is set to False for the zero-level. The flag for the two-level is set False if the difference between the two available data sources is greater than the FDIR limits (range limit 3006 ft, and bearing limit 6°).

In BFS engage cases, if the TACANs miscompare at the two-level, the DG flag is set FALSE and no TACAN data is processed. The ratios/residuals will blank. The crew will have to take actions to solve the TACAN miscompare. Since BFS has no FDIR, only an SF, the BFS will not announce this “Silent Dilemma.” This check is commonly known as the reasonableness test.

### **2.9.6 Post-Selection Filter Protection**

After the range and bearing data has been selected for use by the SF, it is checked once more for any large spikes or glitches in the data. Each processing cycle, the selected data is checked against the data from the last cycle. If the selected data differs by more than a predefined limit, it is flagged invalid. The data from the last cycle is used. The range and bearing limits are:

- Range post-selection filter limit = 10,000 ft
- Bearing post-selection filter limit = 4.5°

## **2.10 FAULT DETECTION, IDENTIFICATION, AND RECONFIGURATION (FDIR)**

Fault Detection (FD) – Compares redundant input data to determine if an out-of-tolerance condition exists.

Fault Identification (FI) – Determines whether a failure has occurred and attempts to identify the failed parameter.

Fault Reconfiguration (FR) – Modes the SF in response to crew commands and identified failures.

The FD process always precedes FI, which always precedes FR. FDIR is not performed at the one-level and zero-level and not in the BFS (remember, the BFS has no FDIR).

### **2.10.1 Fault Detection**

TACAN FD is performed whenever two or more data values are available. A failure is determined by comparing the differences between each TACAN unit and comparing these differences to the range and bearing RM limits. The TACAN range and bearing RM limits are:

- Range threshold = 3006 ft
- Bearing threshold = 6°

A state of miscomparison exists whenever the TACAN differences exceed these RM limits. At the two-level, a miscomparison is equivalent to one out-of-tolerance value. At the three-level, a miscomparison is determined to exist when there are two simultaneous out-of-tolerance values. Each miscomparison and the identity of the TACAN unit is passed to the FI function.

### 2.10.2 Fault Identification

FI monitors the differences indicated from FD and declares the existence of a failure whenever a predetermined number, N, of consecutive miscomparison values is detected. The range and bearing miscomparison (N-counter) limits are

- Range counter limit = 5
- Bearing counter limit = 10

Whenever there is a good comparison and the number of consecutive miscomparison values is less than the limit, the N-counters (three counters for three-level tracking and two for two-level tracking) are reset to zero. N-counters neither reset nor increment if any of the associated data from the TACANs has not been updated (i.e., due to commfault or lock-on). Whenever the number of consecutive miscomparison values equal or exceed the limit, a failure is considered to exist.

After FI determines that a failure has occurred, it annunciates a GPC fault message. It also either identifies the failed parameter or annunciates that a failure has occurred and FI is unable to identify the failed unit (dilemma).

### 2.10.3 Three-Level

When a miscompare is detected by two of the three TACAN error pairs (1-2, 2-3, and 3-1), FI identifies the unit that is common to these pairs as having the failed parameter (i.e., if the range fail counters for TACAN error pairs (1, 2) and (2, 3) are greater than or equal to the counter limit, fail the range parameter on TACAN 2). When a parameter is declared failed by PASS RM, a down arrow is displayed on GNC System Summary 1, an "RM FAIL TAC" PASS fault message appears, a down arrow is displayed on GNC SPEC 50 next to the failed parameter, and an SM alert light and alarm tone are generated. (See [Figure 2-21](#) for Ascent/Entry System Procedure "RM Fail TAC" procedure.)

#### **RM FAIL TAC G50**

(RM LIMITS: 6 DEG, 0.5 NM)

1. If data good: desel, resel aff TACAN >>
2. If failure verified – desel failed TACAN in BFS

#### Rationale

Step 1 handles a transient failure in one of the TACAN's parameters. If the data looks good, reselect the failed TACAN

Step 2 deselects the failed TACAN in BFS. Remember BFS has no FDIR.

**Figure 2-21. RM Fail TAC**

## 2.10.4 Two-Level

When a failure is determined to exist at the two-level, FI annunciates a dilemma and sets the appropriate range or bearing dilemma flag to TRUE. The DG flag is set FALSE in the SF as long as the miscomparison exists (i.e., no TACAN data will be used for that parameter). FI then attempts to discriminate the failed unit's parameter through a TACAN self-test to isolate the failure. If self-test can discriminate, FI identifies both the failed parameter and the unit. Then it resets the dilemma flag to FALSE. If the failure cannot be identified or if self-test was not executed (TACANs in T/R or RCV mode), the dilemma flag and indications remain set TRUE. The crew must manually deselect one of the TACANs. In a PASS RM dilemma, "?" is displayed on GNC SPEC 50 next to the parameters in dilemma, and an SM alert and alarm tone are generated. When self-test is in progress, "TEST" appears on SPEC 50. Upon completion of self-test (if the dilemma is solved), a "RM FAIL TAC" fault message is generated and associated signatures (see RM FAIL signature discussion, [Figure 2-21](#)). See [Figure 2-22](#) for Ascent/Entry System Procedure of "RM DLMA TAC."

### RM DLMA TAC G50

Do not desel or resel while in 'TEST'

1. If both data good: desel, resel one TACAN in DLMA >>
2. √ TACAN MODE (three) – GPC
3. If 'RM FAIL TAC': desel failed TACAN in BFS >>
4. If continuous 'TEST': TACAN MODE (three) – T/R  
If bad TACAN identified:
5. Desel bad TACAN (PASS, √BFS)

#### Rationale

Step 1 handles a transient 40 degree bearing glitch, bearing bias or a range bias. This step has the crew solve the DLMA by desel/resel one TACAN.

Step 2 has the crew check that the GPC MODE is selected; this mode allows self-test to solve DLMA's automatically.

Step 3 has the crew deselect a failed TACAN in BFS, since BFS has no FDIR.

Step 4 has the crew select the T/R MODE if the TACANs remain in self-test. In the T/R MODE, TACANs do not have the automatic self-test capability; so this will stop the continuous self-test.

Step 5 is self explanatory.

**Figure 2-22. RM DLMA TAC**

### 2.10.5 Fault Reconfiguration

Fault reconfiguration modifies the SF by dictating which TACANs may be considered candidates. It responds directly to crew deselect/reselect commands and to identified range or bearing failure indications. If a failure existed at the two-level, thereby setting the dilemma flag TRUE, the dilemma flag is reset to FALSE upon moding to either the three-level or the one-level. See [Table 2-1](#) for SF and FDIR summary; also see [Figure 2-23](#) for Entry Pocket Checklist RM summary.

**Table 2-1. TACAN RM summary for PASS and BFS**

#### RM

\*\* Selection is performed on a parameter basis for Candidate Units \*\*

#### Selection filter

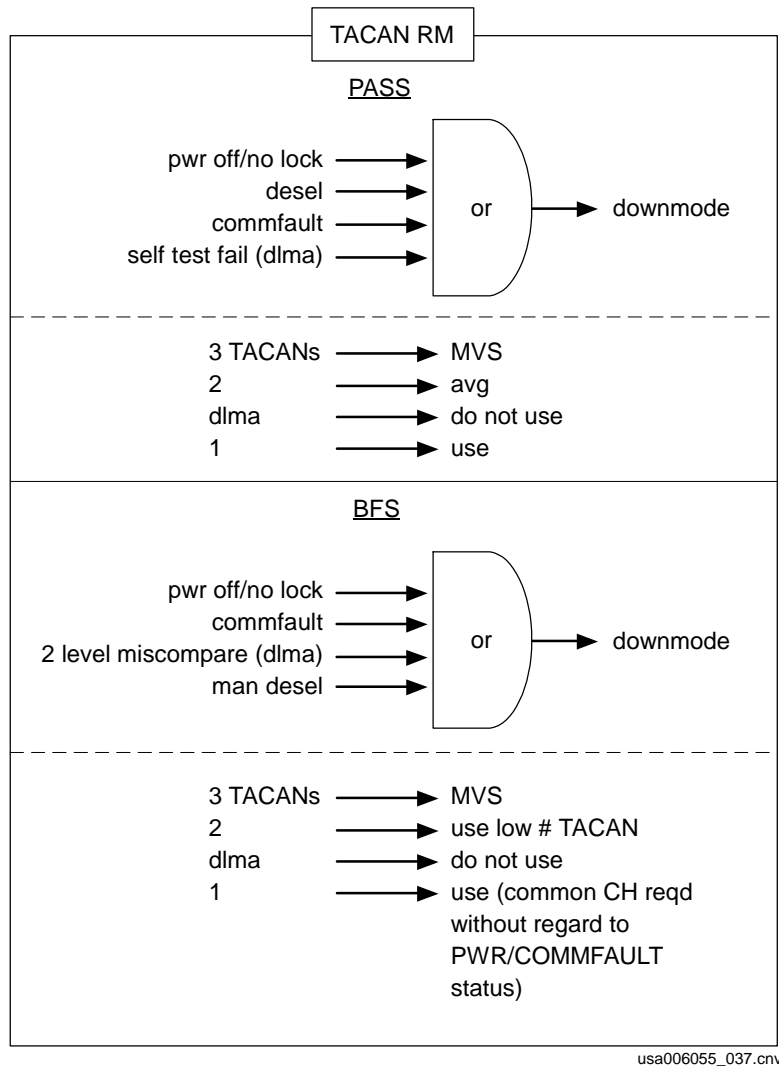
|         | <b>PASS</b>                                  | <b>BFS</b>                                   |
|---------|--|--|
| 3-Level | Component by component MVS                   | Same as PASS                                 |
| 2-Level | Average each component.<br>DLMA – do not use | Use lowest numbered TACAN. DLMA – do not use |
| 1-Level | Use  | Same as PASS                                 |
| 0-Level | Data not used                                | Same as PASS                                 |

#### FDIR

|         | <b>PASS</b>                                      | <b>BFS</b>                |
|---------|--|---------------------------|
| 3-Level | Downmodes based upon two out of three comparison | No FDIR for TACANs in BFS |
| 2-Level | Automatic self-test (if in GPC mode)             |                           |
| 1-Level | None   |                           |
| 0-Level | None   |                           |

\*\* RM limits: Range – 3,006 ft \*\*

Bearing – 6°



**Figure 2-23. Entry pocket checklist TACAN RM summary**

## 2.11 TACAN USAGE IN NAVIGATION

In the Deorbit Prep Checklist, the TACANs are moded to GPC and the ANT SEL switch is checked for the AUTO position (Panel O7) in preparation for entry. The TACANs are also set in this configuration for launch in case of an abort. The TACAN SOP starts processing in MM 304 and MM 602. The Entry Maneuvers Cue Card calls for the crew to check TACANs at V = 7k for nominal End of Mission (EOM). The Ascent Cue Cards tell the crew when to check the TACANs for abort cases.

TACAN acquisition and operation are completely automatic under nominal conditions. The crew is provided with necessary controls and displays to evaluate the TACAN system performance and incorporate the data.

The TACAN scheme is based on common channel operation of the three onboard units; i.e., all three TACANs are tuned to a common ground station. Because the three



TACAN units have different antenna locations, they do not all initially lock on at the same time. Other factors that affect TACAN lock-on are vehicle bank angle and ground station location. At MM 304, the onboard units begin searching for range and bearing lock. They will interrogate the lower and upper antennas alternately approximately 12 seconds each until a range lock is acquired.

MCC (GNC flight controllers) checks the TACANs Automatic Gain Control (AGC) in MM 304 (before the TACANs have locked on to a ground station) for TACAN failed-off blanking pulse. TACANs nominally lock on to the ground station around 160 kft. Therefore, at high altitudes in MM 304, the TACANs are sending full strength range interrogating pulses (5 volts AGC) trying to lock on to a ground station. When the onboard TACAN units lock on, the pulse strength slowly decreases as the ground station range is reduced. The onboard TACAN units are communicating with one another. When one unit sends range (DME) interrogating pulses, the other units receive a blanking pulse to inform the TACAN units that a signal is being sent. If the TACANs are experiencing a failed-off blanking pulse (TACANs are not receiving any blanking pulses from any other TACAN), the units are not communicating with one another. Thus, the units will interfere with one another and affect locking on to the ground station. If the AGC value is high at the MM 304 transition, no failed-off blanking pulse exists. However, if AGC shows low at the MM 304 transition, the TACAN units believe that they are acquiring lock-on with a ground station. A failed-off blanking pulse exists. The units are not communicating with one another and are locking on to one another's transmitted range signals. Testing has shown that, with this failure, the TACANs will not lock on at all during entry if only upper antennas are selected. With lower antennas selected, the TACANs lock on, but slightly higher signal strength is required. The upper antennas are located closer together than the lower antennas. So the failure affects the upper antenna more. The upper antennas are normally used at higher altitudes and the lower antennas used at lower altitudes. So the result of a failed-off blanking pulse is late lock-on of TACANs.

In order for Nav to process range or bearing, each component must separately satisfy a two-lock requirement. The columns for the bearing and range data on SPEC 50 remain blank until the two-lock and acquisition filter requirements are satisfied (10 consecutive cycles required for RNG if ground velocity > 4500 ft/s or 5 consecutive cycles if ground velocity < 4500 ft/s, and 12 consecutive cycles required for Bearing (BRG)). The acquisition filter guarantees that there is a steady lock-on before the data can be used. Since RM operates at 1 Hertz (Hz), there will be 10 to 12 seconds before data appears in the RESID/RATIO column on SPEC 50. Once lock-on is lost, the acquisition filter cycle starts all over again. Typically, two LRUs have locked on in both RNG and BRG at approximately 150 to 145 kft.

Because bearing data is not reliable when flying over a ground station, there is a "Bearing Cone of Confusion" check during which no bearing data is processed. The crew can determine the presence of the bearing cone by observing that the bearing data has blanked in the bearing RESID/RATIO columns on SPEC 50.

The following excerpt from the Flight Rules explains in detail the criteria that the crew and MCC use to assess the value of the TACAN data and its incorporation into navigation. Please read this excerpt carefully for the OPERATIONAL portion of the TACAN system!

**A4-206 NAVIGATION FILTER MANAGEMENT AUTO/INHIBIT/FORCE (AIF)**

*This rule provides direction to the crew and ground for the management of external sensor data incorporation into the navigation filter. It assumes that the crew AIF switches are initially in INHIBIT for TACAN and BARO and in AUTO for drag altitude processing. The rule is presented in matrix form to facilitate correlation of various situations to the action to be taken for those situations.*

A. TACAN-INITIAL PROCESSING (INITIALLY IN INHIBIT) :

|   | RATIO <1                 | RATIO >1   |  | 1-LOCK   |
|---|--------------------------|--|--|--|
|   |                          | BAD TACAN VECTOR   | BAD STATE  |  |
| EARLY NO COMM<br>(V <sub>REL</sub> > 6000 [1] FPS<br>H > 130K FT) | REMAIN IN INHIBIT        | REMAIN IN INHIBIT  | REMAIN IN INHIBIT                                  | REMAIN IN INHIBIT  |
| COMM  | GROUND CALL;<br>AUTO [3] | GROUND CALL;<br>Δ STATE OR INHIBIT<br>FORCE<br>IF STATION, SWITCH<br>TO B/U CH<br>IF LRU,<br>Δ STATE<br>UPDATE<br>AS REQD  | GROUND CALL;<br>RETURN TO<br>AUTO WHEN<br>RATIO <1 | GROUND CALL;<br>DESELECT MISSING<br>TACAN'S<br>(RESELECT NON-<br>FAILED TACAN<br>LRU'S WHEN 2<br>LOCK) |
| LATE NO COMM<br>(V <sub>REL</sub> < 6000 FPS,<br>H < 130K FT)     | AUTO                     | TROUBLESHOOT TO DETERMINE<br>CAUSE OF EDITING<br>A. SWITCH GROUND STATIONS<br>B. CHECK IMU STATUS<br>C. OBSERVE RESIDUAL, RATIO<br>BEHAVIOR<br>D. MONITOR WITH HSI |  | WAIT UNTIL V <sub>REL</sub><br><5500 FPS [2]<br>THEN<br>DESELECT<br>MISSING TACAN'S<br>(DO NOT FORCE)  |
|   |                          | AUTO   | FORCE  |  |

NOTES:

- [1] FOR RTLS, V<sub>REL</sub> < 6500 FPS.
- [2] FOR RTLS, V<sub>REL</sub> < 4700 FPS.
- [3] EVEN THOUGH THE RATIO IS < 1, TACAN DATA WILL NOT BE ACCEPTED IF GROUND RADAR INDICATES THAT INCORPORATION OF DATA WILL DEGRADE THE NAVIGATION STATE. (REFERENCE RULE {A8-52}, SENSOR FAILURES.)

**THIS RULE CONTINUED ON NEXT PAGE**

A4-206

**NAVIGATION FILTER MANAGEMENT AUTO/INHIBIT/FORCE  
(AIF) (CONTINUED)**

*This matrix defines the actions to be taken for initial TACAN processing. For a nominal entry, the TACAN AIF switch is in INHIBIT and the TACAN transceivers are turned to the primary site TACAN channel with the rotary switch in the GPC position. When two TACAN LRUs have locked up, RM passes data to the navigation filter; but, because the AIF control is in INHIBIT, the data will not be processed by navigation. This configuration allows the ground to evaluate the TACAN data compared to radar tracking data and to give the crew a GO to mode the AIF switch to AUTO, so that navigation may process TACAN if it is acceptable. This plan also protects the validity of the ground delta state computation in the event that a ground- initiated vector update is required. (The ground delta state processor requires that external data not be taken in since it assumes that the state errors are linear). The early NO-COMM row of the rule matrix supports this mode of operation by having the crew wait for COMM in order to have ground assistance. However, there is a limit to how long the crew should wait before they try to independently troubleshoot the lack of good TACAN data. For EOM, this limit was chosen to be about 130k feet, which corresponds to a Relative Velocity ( $V_{rel}$ ) of approximately 6000 fps. At this altitude, it is becoming more urgent to correct the vehicle state since the footprint is shrinking (for RTLS, 130k feet altitude corresponds to a  $V_{rel}$  of approximately 6500 fps).*

*In the COMM row, for TACAN data that agrees with the navigation, the ratios will be less than one. Upon ground evaluation of the TACAN data and of the onboard vector compared to tracking data, a GO will be given for the crew to go to AUTO. However, if the ground evaluation shows that incorporation of the TACAN data will degrade the navigation state, the TACAN data will be held out until it will improve the onboard state. Analysis shows that ground station biases greater than 0.3 nm. in range or 1 degree in bearing can result in position delta state limit violations (ref. Rule {A4-204}, DELTA STATE POSITION UPDATES) in the absence of all other navigation error sources. If the ground determines that the TACAN data compared to the tracking data indicates a bias on all three LRUs greater than 0.3 nm or 1 degree, the recommendation will be to try another ground station. If, at the TACAN 2-LRU level, the average LRU measurement error (based on tracking) is greater than 0.3 nm or 1 degree and RM limits are not exceeded, the larger biased LRU will be deselected. Multiple LRU biases can escape RM detection and still significantly degrade the navigation state. LRU deselection will be performed only if that action will reduce the bias in the selected measurement to less than 0.3 nm or 1 degree.*

*One of two failures can cause the ratios to be greater than one. Either the TACAN or the state vector could be at fault. If the ground-station-to-tracking compares are good, then the fault lies with the onboard system. If the fault lies with the onboard system and the delta state update criteria are exceeded, an update will be initiated. If the ground determines that the vehicle state is erroneous and the TACAN residuals indicate that forcing the data will correct the state error, then the crew will be advised to force the data until the ratio is less than one at which time they will be advised to return to AUTO. Otherwise, a delta state update will be performed.*

**THIS RULE CONTINUED ON NEXT PAGE**

A4-206

NAVIGATION FILTER MANAGEMENT AUTO/INHIBIT/FORCE  
(AIF) (CONTINUED)

*The final entry in the COMM row deals with only one LRU locking up. At initial acquisition, the onboard redundancy management requires that two LRUs be locked on before data is passed to navigation. If only one LRU locks on, the crew/ground should verify that the data is good for that LRU, and the crew should deselect the missing LRUs to override the two-lock requirement. Once data is processed initially, the range two-lock restriction is satisfied, but two LRUs are still required to be locked on prior to processing bearing data. Therefore, it is advisable to wait until two LRUs are locked on prior to reselecting non-failed LRUs. This provides RM protection for both range and bearing. However, if the ground deems it necessary to process data from one LRU, then this procedure would be used and, during the period of one LRU lock, the ground would carefully monitor the quality of the data from the single LRU.*

*In the NO-COMM case, the crew must make decisions in the operations of the AIF controls independently from the ground. The NO-COMM case may be assumed by the crew if they are entering to a landing site that has no COMM with the ground or to a site that has COMM, but COMM has not been established by  $V_{rel}=6000$  fps. If the TACAN deltas on the HSD look good and the ratios are less than one, then the crew should mode the AIF switch to AUTO. If the ratio is greater than one, the crew must use onboard displays to determine whether the TACAN or state vector is bad. The following procedures are available to the crew:*

- a. Switch ground stations - The onboard I-loads for the TACAN table are such that, with the rotary switch in the GPC position, the landing site TACAN should be acquired. If data is not acquired or if the ratio is greater than one, the crew may execute item 5 on GN: SPEC 50 to select the alternate or backup TACAN and evaluate that data. If the ratios for the alternate station are less than one, then the problem is probably with the prime TACAN ground station. If the ratios are greater than one, it would probably indicate a bad navigation state, although there is a very small probability that two or more LRUs would fail in the same manner.*
- b. Check IMU status - If the IMU mission performance has been nominal and a good IMU alignment was performed pre-deorbit, and no IMU failures have occurred during entry, it is unlikely that the navigation state could be in error by a sufficient magnitude to cause ratios greater than one. Therefore, the TACAN data should be suspect. However, if the IMUs have had problems or an alignment was not performed pre-deorbit, or an IMU has failed RM during entry, the crew should suspect that the navigation state is in error.*
- c. Observe residual/ratio behavior - If the residuals/ratios are steady or show a constant trend, it is likely that the navigation state is in error. If the residuals/ratios are erratic, it is likely that the TACAN data is erroneous.*
- d. Monitor with HSI - The crew can select raw TACAN data to drive the HSI and compare the range and bearing with the navigated position and a visual estimate of the real position. This would be a difficult procedure since the values on the HSI will be continually changing and the magnitude of the errors would have to be so large that the source of the error should have already been detected by one of the other methods.*

THIS RULE CONTINUED ON NEXT PAGE

A4-206

**NAVIGATION FILTER MANAGEMENT AUTO/INHIBIT/FORCE**  
**(AIF) (CONTINUED)**

*The final situation in the NO-COMM row is the case where only one LRU locks on. In this case, the crew should wait as long as possible before the footprint shrinks to the point that the state error really has to be removed (5500 fps for EOM and 4700 fps for Glide Return to Landing/Launch Site (GRTLS)). At this point, the nonlocked on LRUs should be deselected and the data from the single LRU passed to navigation by moding the AIF switch to AUTO. It should not be moded to FORCE to protect the navigation from bad TACAN data.*

B. TACAN - POST CONVERGENCE (INITIALLY IN AUTO) :

|         | RATIO <1                 | RATIO >1  |  |
|---------|--------------------------|---|--|
|         |                          | BAD TACAN   | BAD STATE VECTOR   |
| COMM    | GROUND CALL;<br><br>AUTO | GROUND CALL;<br><br>INHIBIT<br><br>IF STATION, SWITCH TO B/U CH<br><br>IF LRU,<br>Δ STATE UPDATE<br>IF REQ'D. (BACK TO AUTO IF RATIO <1)                        | REMAIN IN<br><br>AUTO<br><br><br><br><br>PERFORM A ZERO Δ STATE UPDATE. IF RATIO STILL >1; FORCE |
| NO COMM | GROUND CALL;<br><br>AUTO | TROUBLESHOOT TO DETERMINE CAUSE OF EDITING<br><br>A. OBSERVE RESIDUAL, RATIO BEHAVIOR<br>B. CHECK IMU STATUS<br>C. MONITOR WITH HSI<br>D. SWITCH TACAN STATIONS |  |
|         |                          | REMAIN IN<br><br>AUTO   | REMAIN IN<br><br>AUTO<br><br>PERFORM A ZERO Δ STATE UPDATE. IF RATIO STILL >1; FORCE             |

*This rule shows the actions to be taken once TACAN data has been processed by navigation. For a nominal entry, the crew action would be to remain in AUTO for either COMM or NO-COMM since the ratio should not grow above one. If, for any reason, the ratio does become greater than one, then the ground or the crew can utilize the same techniques to isolate the problem as were used at initial acquisition. If the problem is bad TACAN data, the actions are the same as at initial acquisition. If the problem is the navigation state, the procedures change slightly in that a zero delta state update is performed prior to applying the same procedure used for the initial acquisition case. This is done to reinitialize the covariance if TACAN data has already been processed and it is required to force TACAN in order to fix the navigation state, since the processing of TACAN data might have converged the covariance matrix to the point where even forcing the TACAN data would not remove the state errors.*

The detailed matrix that is displayed in flight rule A4-206 is not flown. However, a shorter version called the NO COMM TACAN MGMT Cue Card shown in [Figure 2-24](#) is flown in the entry checklist.

| V = 6K    |              | NO COMM TACAN MGMT                          |  |                                |
|-----------|--------------|---|--|--------------------------------|
| RATIO < 1 | RATIO > 1    |   | ONE TACAN LOCKED                                       |                                |
| AUTO      | TROUBLESHOOT |   | BELOW V = 5.5K<br>DESELECT MISSING TACANS, then - AUTO |                                |
|           | IF BAD TACAN | IF BAD NAV STATE                            |  | BELOW V = 5.5K<br>TOGGLE TACAN |
|           | AUTO         | If 1st acq - FORCE<br>IF NOT - ZERO Δ STATE |  |                                |

**Figure 2-24. NO COMM TACAN MGMT**

## 2.12 LAUNCH COMMIT CRITERIA REQUIREMENTS

Two of three TACANs are required for launch up until T-31 seconds at Redundant Set Launch Sequencer (RSLs) start. AGC must also be within limits for launch up until RSLs start at T-31 seconds. Two of three range and two of three bearing values must be valid at the one-time verification test before Ground Launch Sequencer (GLS) start at T-9 minutes. All the above criteria must be met, or an auto hold will take place. For OV-104, either TACAN 2 or GPS 2 is required.

## 2.13 BFS DIFFERENCES

1. The Pilot (PLT) HSI switch positions are slaved to the CDR positions when BFS is engaged.
2. BFS has different status indicators than PASS on SPEC 50 (Horiz Sit) and SPEC 18 (GNC SYS Summ 1). For BFS, down arrows are used for commfault/loss of lock and unit failed. Data for each TACAN unit will be static. PASS uses an "M" for Commfault/Loss of Lock, and data will be dynamic (desel/failed) or blank (commfault/loss of lock).
3. BFS does not support the "TEST" function on SPEC 50 because it has no FDIR, only an SF. BFS also does not support DELTA mode on SPEC 50, only the ABS mode.
4. BFS issues a "NAV EDIT" fault message when TACAN range or bearing ratio >1 for three consecutive Nav cycles; PASS does not.

5. BFS does not issue a “NAV EDIT TAC” fault message if TACAN data is not incorporated into Nav after seven Nav cycles; PASS issues the message only.
6. BFS does not support the “RM FAIL TAC” and the “RM DLMA TAC” fault messages because BFS has no FDIR.
7. BFS does not support OPS 8 Sensor Test and OPS 9 Sensor Self-Test displays. BFS is not informed of sensors deselected on SPEC 40 (Sensor Test) in OPS 8; therefore, it is important to turn these units off or deselect them in the BFS.
8. No two-lock requirement in BFS, only two conditions
  - a. At least two TACANs tuned to the same station, as seen on SPEC 50
  - b. One TACAN locked on
9. The BFS SF at the two-level is different than PASS. The BFS uses the lowest numbered TACAN. If a miscompare exists between the two remaining TACANs, the BFS does not use any data because the reasonableness test failed.
10. BFS will DK listen to the ITEM entries on PASS SPEC 50 for deselection/reselection of TACAN units. For example, if an ITEM 32 is performed on PASS SPEC 50, BFS executes the ITEM 32 on its SPEC 50.

## **QUESTIONS: TACANS**

1. Which two parameters do TACANs provide to navigation?
2. When is TACAN data used: (altitude)?
3. How does the orbiter TACAN unit measure range?
4. When would you get a BCE STRG X TAC fault message?
5. Where are the TACAN cb's found and what bus powers them?
6. The HSI can be used as a tool to solve TACAN dilemmas. True or False?
7. What are the two basic functions performed by TACAN RM?
8. BFS software has only an SF, no FDIR. True or False?
9. What are the TACAN RM limits?
10. Can BFS annunciate an RM Fail TACAN fault message if a miscompare exists at the two-level?



**ANSWERS: TACANS**

1. Slant range and magnetic bearing
2. TACAN data is used from approximately 160k unit MLS acquisition or until 1500 ft if MLS is not available.
3. Range is determined by measuring the time difference between transmission of pulses from the airborne TACAN unit to the ground station and reception of the reply pulses from the ground station back to the airborne unit.
4. If the special TACAN/RA IOM fails in the MDM
5. PNL 014, 015, 016; MNA, MNB, and MNC
6. True, each TACAN unit can be compared to Nav using the HSI source switches.
7. Selection filter  
FDIR
8. True.
9. Range: 3006 ft  
Bearing: 6°
10. No. BFS has no FDIR, only SF.

### **3.0 MICROWAVE LANDING SYSTEM**

#### **3.1 INTRODUCTION**

The orbiter contains three MLS units operating in a triply redundant mode. Upon switchover from TACANS at an altitude of approximately 18,000 feet, the shuttle MLS provides the orbiter with precise azimuth angle, elevation angle, and distance (slant range) information with respect to the runway during the final approach and landing phase.

#### **3.2 PERFORMANCE OBJECTIVES**

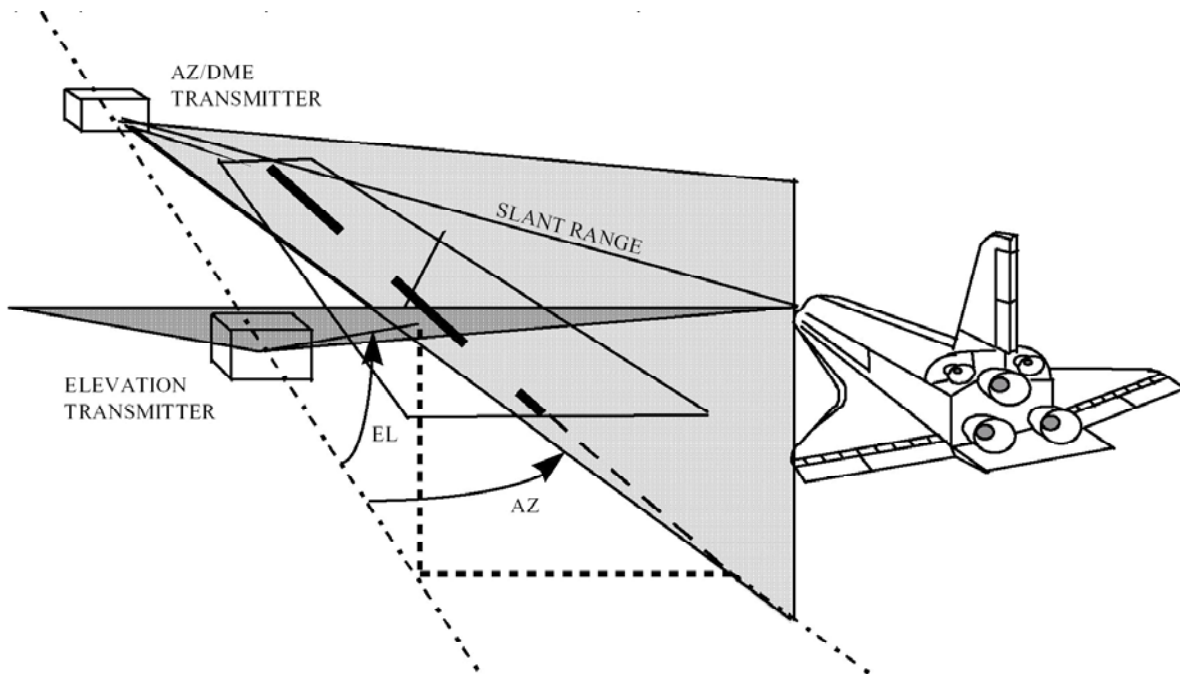
As a result of studying this section, the student should be able to do the following:

- a. State when MLS data is used
- b. Describe the parameters that MLS provides to Nav
- c. Name the two channels that have been cleared for orbiter landing operations
- d. Describe when MLS FDIR is processing
- e. Describe the MLS RM limits
- f. Explain which parameters are required for MLS processing
- g. Explain the difference between Preland Nav and Entry Nav

#### **3.3 MICROWAVE LANDING SYSTEM OPERATION**

*Figure 3-1* illustrates the transmitted microwave beams and measurement geometry of the MLS. The MLS consists of a ground station (MLS-GS) and an airborne Navigation Set (MLS-NS). The MLS-NS is composed of two LRUs: The Radio Frequency (RF) assembly and the decoder assembly. The ground station is a split-site configuration: Azimuth (AZ) and ranging information are transmitted from the AZ and DME transmitter. Elevation (EL) information is transmitted from the EL transmitter. The AZ and DME transmitters are located beyond the end of the runway. The EL transmitter is located near the touchdown point. The surveyed locations of the three MLS transmitters are stored in memory onboard the orbiter and are used in conjunction with the AZ, EL, and RNG data to determine the orbiter position with respect to the runway.

The MLS has 10 frequency channels between 15.4 and 15.7 Gigahertz (GHz). However, since there are other users for this system, only channels 6 and 8 have been cleared for orbiter landing operations. Each shuttle ground station is permanently assigned to either channel 6 or 8. For entry and landing, the channel number for the designated runway is selected onboard the orbiter with a set of thumbwheels.



**Figure 3-1. MLS beams and measurement geometry**

### 3.3.1 Ground Station Hardware

*Figure 3-2* from the Entry Checklist lists some of the landing sites, runways, and assigned channels where MLS ground stations are installed. The MLS-GS consists of two equipment shelters, two external monitoring antennas, and a remote control unit. One shelter contains the AZ and DME assemblies. The other contains the EL assembly. Each shelter contains redundant sets of equipment (one set forming a primary string and the other a backup string). One of the external monitoring antenna monitors AZ/DME performance. The other monitors EL equipment performance. The two external monitoring antennas house three redundant antenna sets. The remote control unit allows the operator to concurrently monitor the operation of the primary and backup strings and to intervene and override the automatic controls as necessary.

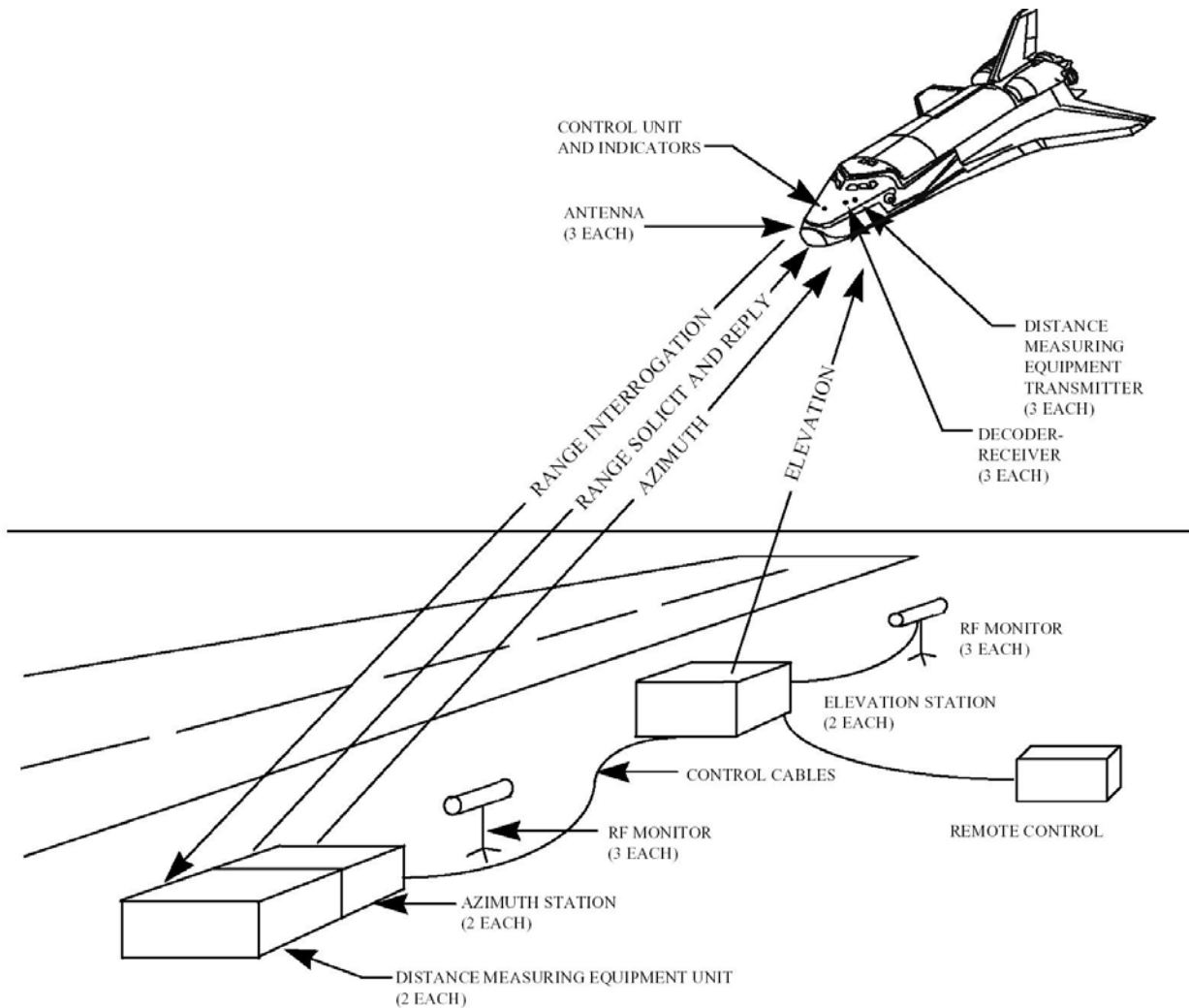
**STS-114  
LANDING SITE TABLE  
(OPS 1/6/3)  
(50° to 53.5° INCLINATION)**

| S<br>I<br>T<br>E | LOCATION                 | RWY                | TACANS      |               | MLS<br>CH | LG             |
|------------------|--------------------------|--------------------|-------------|---------------|-----------|----------------|
|                  |                          |                    |             | ITEM 5        |           |                |
| 1                | KSC                      | KSC 15<br>KSC 33   | TTS 59Y     | OMN 73        | 8<br>6    | 15000<br>15000 |
| 2                | BEN GUERIR               | BEN 36<br>BEN 18   | ◆BEN 108    | CBA 116 (DME) | ◆6<br>-   | 13720<br>12720 |
| 3                | MORON AB                 | MRN 20<br>MRN 02   | MRN 100     | AOG 23        | ◆6<br>-   | 11929<br>11729 |
| 4                | ZARAGOZA                 | ZZA 30L<br>ZZA 12R | ZZA 64      | ZZA 77 (DME)  | ◆6<br>-   | 12397<br>12197 |
| 5                | CHERRY POINT             | NKT 32L<br>NKT 23R | NKT 75      | EWN 83 (DME)  | -<br>-    | 8402<br>8482   |
| 6                | OCEANA NAS<br>WILMINGTON | NTU 23L<br>ILM 06  | NGU 48<br>- | -<br>ILM 117  | -<br>-    | 11997<br>8000  |

Figure 3-2. Landing site data from entry checklist

Each ground station string is powered by batteries that are continuously charged from ac input power. If ac power is lost, the ground station continues to function from the batteries for at least 15 minutes.

Each ground station is aligned with respect to the runway to within 0.015° in AZ and EL and periodically verified by ground test and flight inspections. *Figure 3-3* shows the MLS-GS hardware configuration.



**Figure 3-3. MLS-GS major components**

A low-cost MLS-GS for space shuttle contingency landing sites also exists. It has a single shelter, no ground station redundancy, and no battery backup. See [Table 3-1](#) for MLS-Junior details.

**Table 3-1. MLS-GS and MLS-JR hardware**

**MLS-GS hardware**

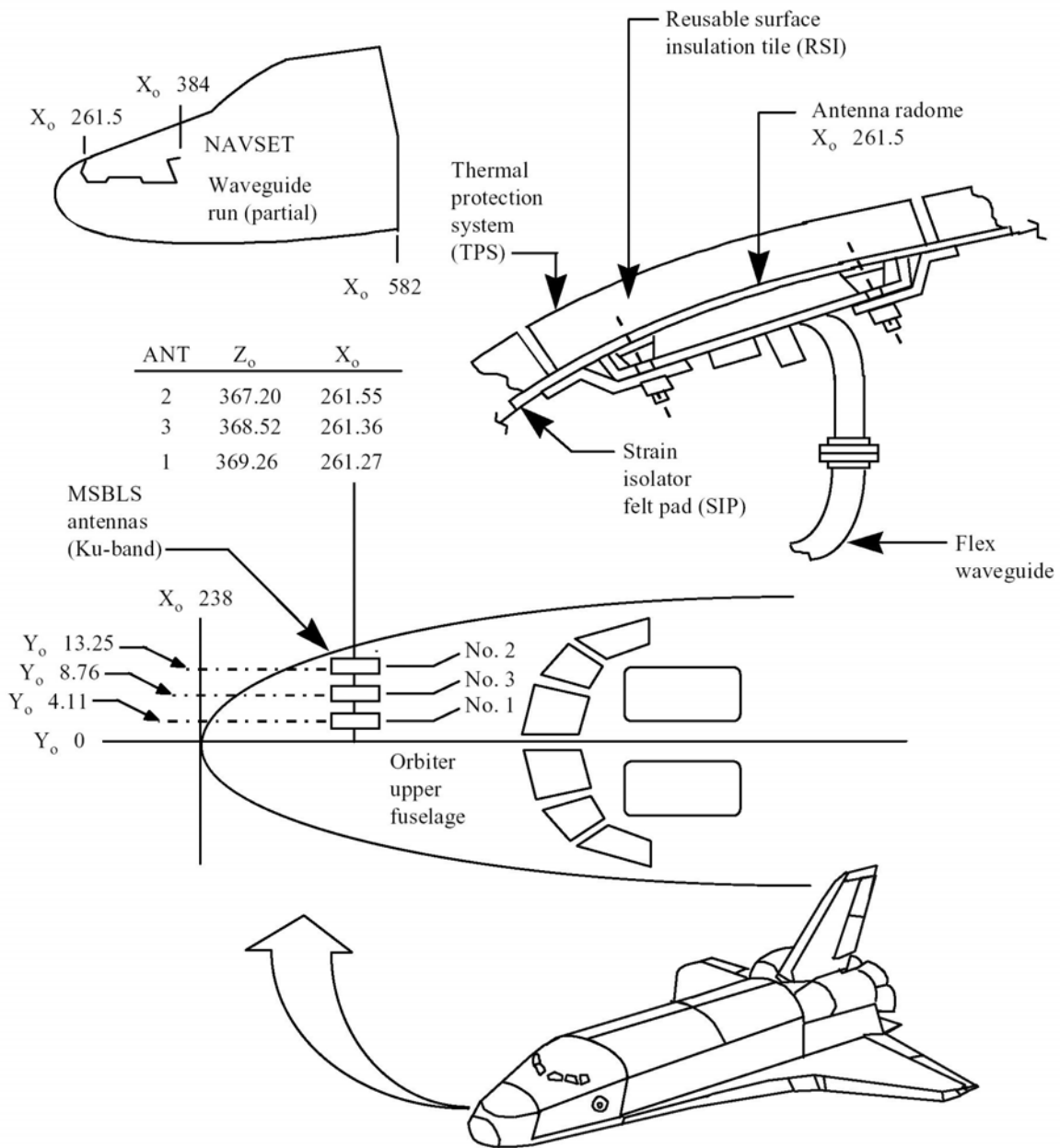
- \* Separate elevation and azimuth/range shelters
  - \* Dual redundant ground stations
  - \* Triply redundant field monitoring antenna at each shelter
  - \* Manual monitoring and control at remote control unit
  - \* Continuous automatic monitoring and switchover/shutdown logic
  - \* Dual redundant ac power
  - \* Fifteen-minute battery backup
- 

**MLS-JR hardware**

- \* Single collocated elevation/azimuth/range shelter
- \* No ground station redundancy
- \* Single nonredundant field monitoring antenna
- \* Manual monitoring and control at shelter
- \* Continuous automatic monitoring and shutdown logic
- \* Dual redundant ac power
- \* No battery backup

**3.3.2 Orbiter-Related Hardware**

Uplink and downlink MLS signals are coupled simultaneously to each of the three redundant MLS-NS through three dedicated forward-looking antennas, shown in [Figure 3-4](#). Separate antennas and hardware interfaces permit each MLS-NS to operate independently.



**Figure 3-4. MLS antenna locations on orbiter**

The MLS-NS LRU assemblies are triply redundant units that are shock-mounted in the orbiter forward avionics bays 1 and 2. The accuracy of the MLS-NS is as follows:

Angle:  $\pm 0.001^\circ$

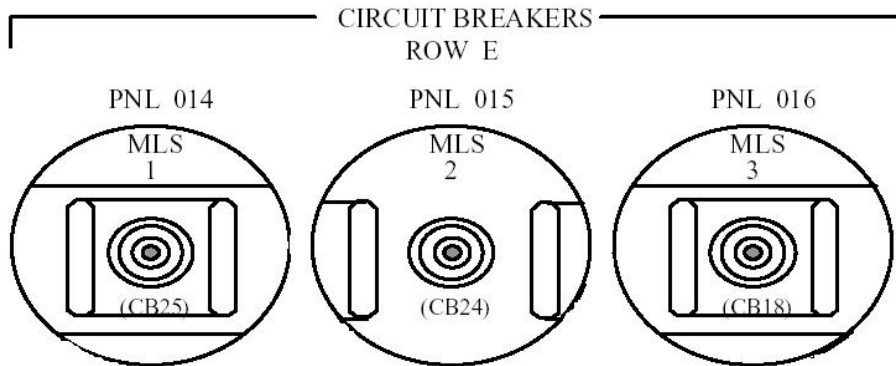
Range:  $\pm 50$  feet

Data transfer between MLS 1, 2, and 3 and the DPS is through flight-critical forward MDMs FF1, FF2, and FF3, respectively. Raw MLS data is also downlinked to the ground by Pulse Code Modulation (PCM) telemetry through Operational Instrumentation (OI) MDMs at 1 sample/sec.

MLS-NS Built-In Test Equipment (BITE) circuitry provides a method to check for failures throughout the functional path of the system continuously during normal operation and during a specially commanded self-test routine in OPS 8 or OPS 9. Self-test causes a reply signal to be simulated, providing fixed known outputs for evaluating the operation of this system. In OPS 8 and 9, self-test causes BITE to be displayed on the Sensor Self-Test display (SPEC 40) if a BITE is detected.

### 3.4 MICROWAVE LANDING SYSTEM CREW CONTROLS

The MLS receives power from Main Buses A, B, and C through the cbs on Panels O14, O15, and O16 ([Figure 3-5](#)). When the cbs are activated, power is applied to the MLS power ON/OFF toggle switches on Panel O8 (see [Figure 3-6](#)).



**Figure 3-5. MLS circuit breakers on Panels O14, O15, and O16**



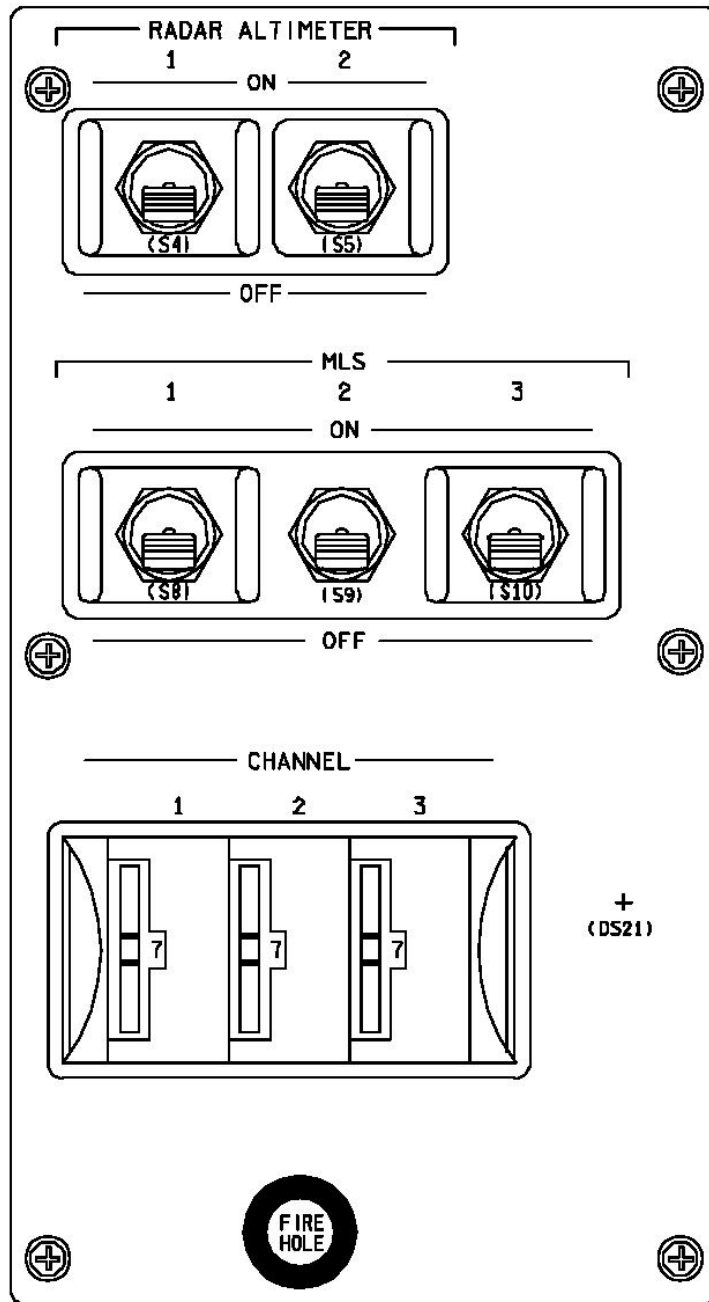
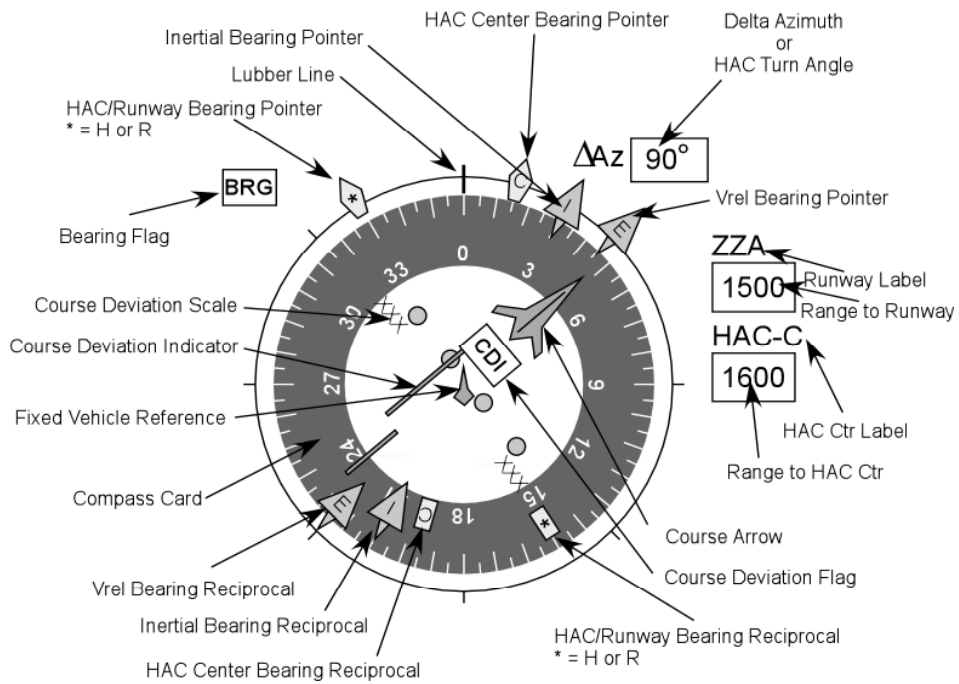
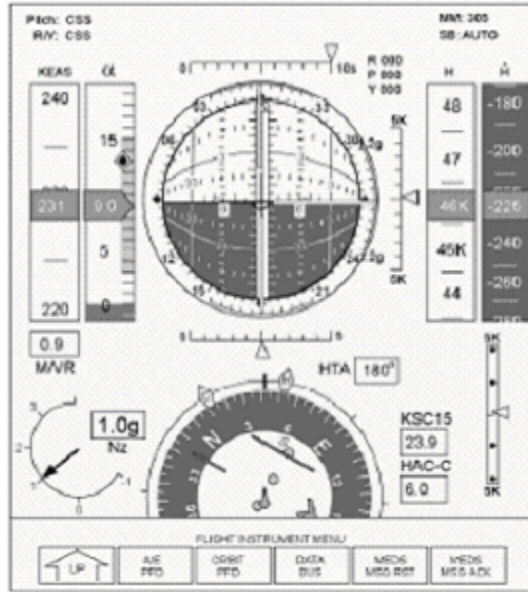


Figure 3-6. MLS power switches and channel thumbwheels on Panel O8

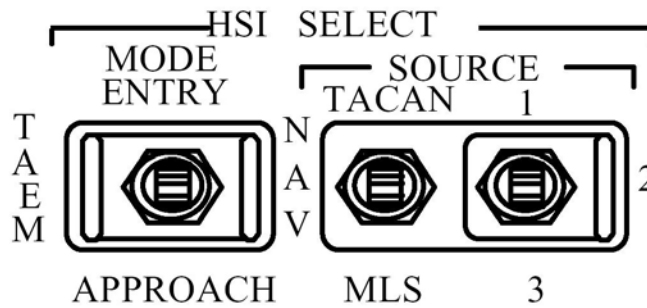
The CHANNEL select switches are located on Panel O8 (*Figure 3-6*). A separate CHANNEL select switch is dedicated to each MLS. The CHANNEL select switch is a 10-position thumbwheel switch (0-9) that allows the crew to select the MLS channel for the ground station located at the selected runway. MCC does not have insight into the channel selected on Panel O8.

The HSI SELECT switches, which are located on Panels F6 and F8 (*Figure 3-8*), control the data input to the HSIs on the MEDS Flight Instrument Display (see *Figure 3-7*). The MODE switch provides a signal to the GPCs, which select data to display for the Entry, TAEM, or Approach and Land phase of flight. When the SOURCE switch is set to MLS, the HSI displays area navigation data calculated using raw MLS data (as opposed to TACAN) from one of the three MLS units, as selected on the adjacent toggle switch. When the SOURCE switch is set to Nav, the HSI displays data from GPC Navigation.

Note: Each MLS unit can be compared to Nav using the HSI SOURCE switches. This is the tool available for the crew to use to solve MLS dilemmas.



**Figure 3-7. Horizontal Situation Indicator (HSI) and A/E PFD (for GSI)**



**Figure 3-8. HSI select switches on Panels F6 and F8**

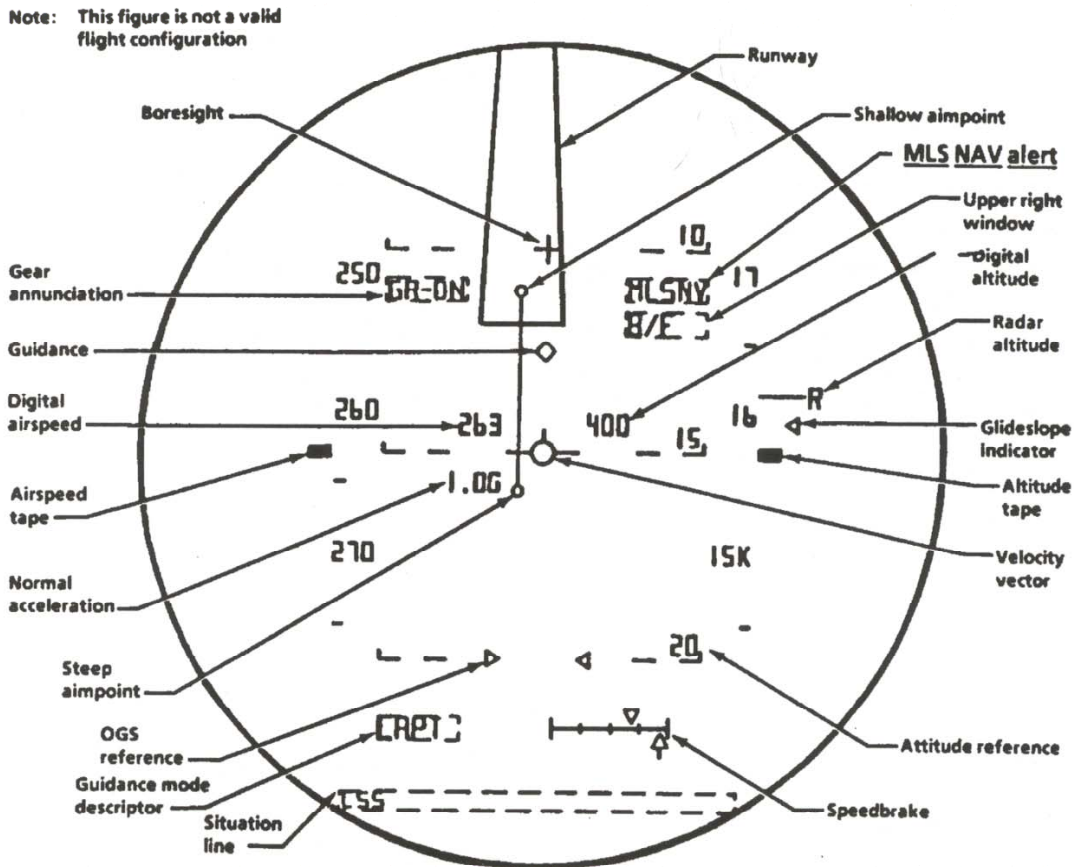
Raw MLS data or MLS-derived information from GPC Nav is presented to the crew on the HSI of the MEDS Flight Instrument display (if the source switch is selected to MLS) and the Heads-Up Displays (HUDs).

The CDI is displaced from the center of the HSI by MLS azimuth data. Displacement toward the dots on the right tell the crew to fly toward the right. Corrections are always made by flying in the direction of displacement.

Elevation data drives the glide slope deviation indicator. Elevation angle is represented by a pointer and accompanied by a scale. When the orbiter is below the desired flight path angle, the pointer indicates this by moving to a position above the HSI centerline. In this manner, the pointer is a fly-to indicator.

Range information is displayed in the upper left and right corners of the HSI. This range is the distance to the primary and secondary waypoints (guidance points along the entry trajectory). Labels are displayed above the numbers to indicate what guidance point each range corresponds to.

Guidance information is presented to the crew on two HUDs. Images of flight-critical information in various formats are projected from a cathode-ray tube into the commander's and pilot's line of sight. This allows the crew to see the displayed information while looking out the window. Display format 1 (approach and landing) is shown [Figure 3-9](#).



**Figure 3-9. HUD display format 1 (approach and landing)**

In the upper right window of the HUD display, "MLS NV" alerts the crew if certain conditions are not met. For this alert, Nav is continuously checking for MLS data at an altitude of 12,000 ft and below. If MLS data is lost for more than 6 seconds after having once been acquired, an "MLS NV" alert message is displayed.

If none of the following conditions are met, "MLS NV" is seen in the HUD:

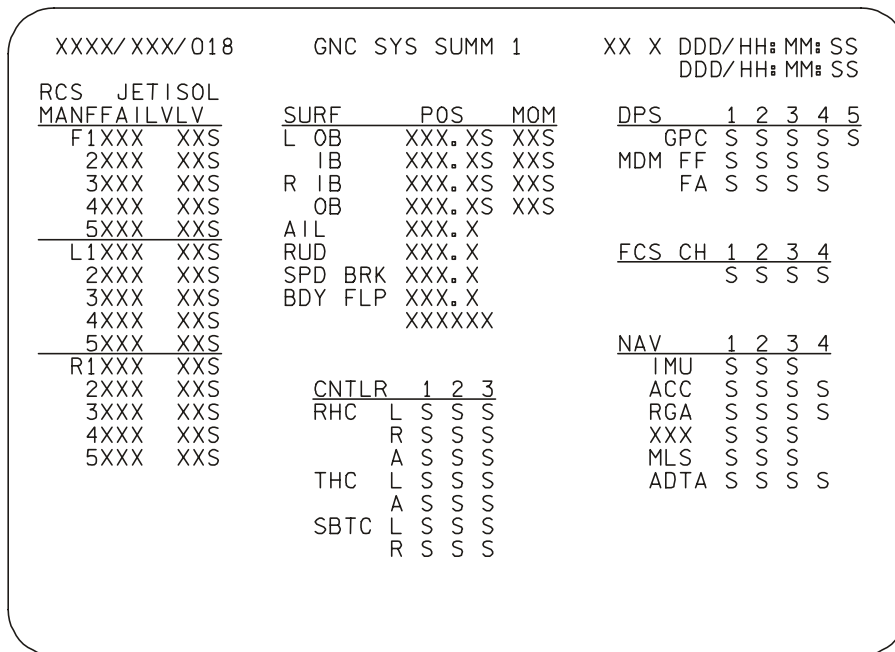
- Orbiter is above 12,000 ft.
- MLS is not supported at the selected runway.
- MLS range, azimuth, and elevation are being processed.
- MLS range and azimuth are being processed, but elevation is being inhibited due to the orbiter being above or below the scan box of the ground station elevation antenna.

### 3.5 MICROWAVE LANDING SYSTEM DPS DISPLAYS

MLS information is displayed on four PASS DPS displays: GNC SPEC 50 HORIZ SIT (when MLS is processing), GNC SYS SUMM 1 (the MLS portion is supported in OPS 3 and 6), SENSOR TEST in OPS 8, and SENSOR SELF-TEST in OPS 9.

#### 3.5.1 SPEC 18 - GNC SYS SUMM 1 Display

The GNC SYS SUMM display shows the operational status of the GNC systems and supports the GNC C&W system ([Figure 3-10](#)). The display is available by using the SYS SUMM key or by calling up SPEC 18. The lower right corner of the display shows the status of the Nav systems, including the MLS. The status columns for each unit may show blank (system OK), a down arrow (unit failed), "M" (data missing due to commfault or loss of lock), or "?" (dilemma). GNC SYS SUMM 1 is a noninteractive display.



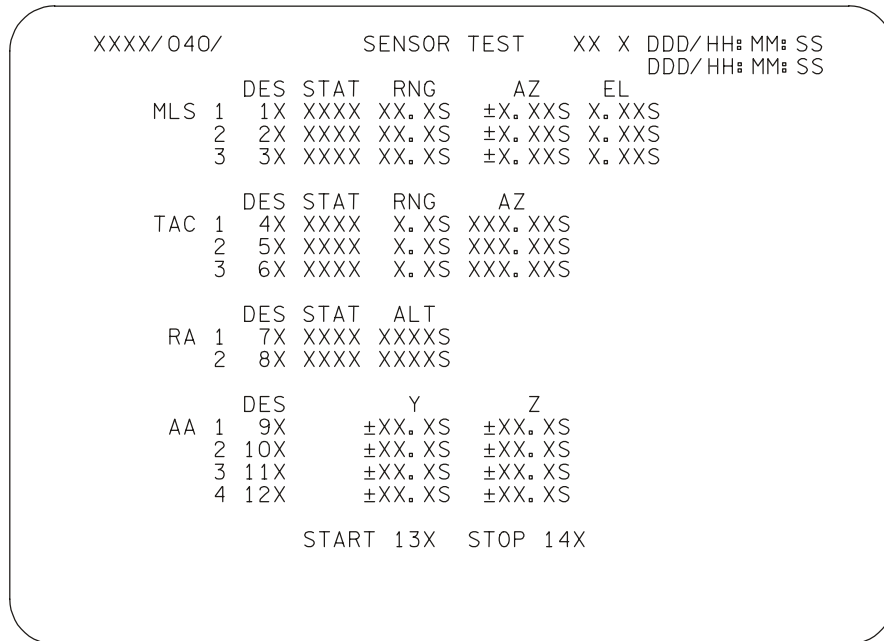
006055007. CRT, 1

Figure 3-10. GNC system summary 1 display

#### 3.5.2 SPEC 40 - Sensor Test Display

The Sensor Test display ([Figure 3-11](#)), which is available in OPS 8 and can be called up with SPEC 40 PRO, provides a means of initiating, monitoring, and terminating the self-test of the MLS.

Execution of a DES item number changes the selection of an MLS unit as a candidate for the SF. An "\*" appears next to the item number if the corresponding unit is deselected as a candidate. The SF configuration from this display is carried over into OPS 3.



TEST LIMITS ARE AS FOLLOWS:  
 RANGE 15.1±0.2 n.mi.  
 AZIMUTH: 3.0°±0.1°  
 ELEVATION 6.0°±0.1°

006055009.CRT; 2

**Figure 3-11. Sensor Test**

RNG in nautical miles, AZ in degrees, and EL in degrees are displayed for each MLS unit. These values are compared to the self-test limits. A status indicator is displayed beside each test parameter indicating the results of the tolerance check. If the BITE indicator is set, BITE appears in the status column. It will blank when the condition is corrected. The self-test controls are shown at the bottom of the display. Item 13 starts the test. Execution of Item 14 stops the self-test. An “\*” appears next to Item 13 or 14 which are initialized blank.

### 3.5.3 SPEC 101 - Sensor Self-Test Display

The Sensor Self-Test display is available in OPS 9 through SPEC 101 PRO for preflight and postlanding checkout of the MLS and other sensors ([Figure 3-12](#)). It is the ground test equivalent of the on-orbit Sensor Test (SPEC 40).

```

XXXX/ 101/      SENSOR SELF-TEST      XX X DDD/HH: MM: SS
                                     DDD/HH: MM: SS

  ENA STAT  RNG      AZ      EL
M1  1X XXXX XX.XS ±X.XXS X.XXS
L2  2X XXXX XX.XS ±X.XXS X.XXS
S3  3X XXXX XX.XS ±X.XXS X.XXS

  ENA STAT  RNG      AZ
T1  4X XXXX X.XS XXX.XXS
A2  5X XXXX X.XS XXX.XXS
C3  6X XXXX X.XS XXX.XXS

  ENA STAT  ALT
R1  7X XXXX XXXXS
A2  8X XXXX XXXXS

  ENA      Y      Z
A1  9X      ±XX.XS ±XX.XS
A2  10X     ±XX.XS ±XX.XS
3   11X     ±XX.XS ±XX.XS
4   12X     ±XX.XS ±XX.XS

TEST CONTROL:
START      13X
AUTO SEQ   14X
TERM       15X

INH ALL 16X

```

006055006. CRT: 1

**Figure 3-12. Sensor Self-Test**

### 3.6 ORBITER MICROWAVE LANDING SYSTEM SOFTWARE

The three MLS units provide azimuth, elevation, and range data for navigation updates and crew display. The MLS software begins processing in the PASS upon transition to MM 305 from MM 304 and MM 603 from MM 602. It is also tested in the on-orbit self-test (GNC OPS 8) before deorbit. MLS is not processed by the BFS.

The capability for manual deselection (downmoding) of MLS units through software is provided only in OPS 8 via SPEC 40. MLS units deselected in OPS 8 remain deselected across OPS transitions. Automatic deselection capability is provided only by RM, starting in MM 305.

### 3.7 SUBSYSTEM OPERATING PROGRAM

The MLS SOP converts the MLS data into a format that can be used by other software modules and routes it to them. The SOP sends three sets of range, azimuth, and elevation data to RM. RM then sends to Nav the RM-selected range, azimuth, and elevation to be used as a source in state vector updates. The three sets of data are also sent to the GPC Nav module of navigation software for HSI display processing at a rate of 3.125 Hz.

To minimize errors due to weak signal strength, a limit check is performed on the raw data against the I-loaded limits listed below.

- a. Shuttle heading with respect to selected runway centerline must be within  $\pm 55^\circ$  to satisfy elevation and azimuth.



- b.  $0.5 < \text{Elevation} < 29^\circ$ .
- c. Azimuth  $< \pm 13.5^\circ$  of runway centerline
- d. Range  $< 15$  n.mi.

### **3.8 REDUNDANCY MANAGEMENT**

The MLS RM software performs two major functions: SF and FDIR. The SF is used to select a range, azimuth, and elevation parameter from multiple data sources or candidates. These parameters can then be declared failed through the FDIR. FDIR searches for faulty data, attempts to identify the MLS unit producing this data and, if successful, reconfigures the SF to exclude data from the faulty MLS. The FDIR function presently runs only in OPS 3 and 6 in PASS nor in the BFS. The SF runs in OPS 3 and OPS 6 in PASS only. MLS RM information is displayed on the GNC SYS SUMM 1 display, the HSI, and the HUD.

### **3.9 SELECTION FILTER**

The purpose of the MLS SF is to select single values of range, azimuth, and elevation (from the available candidates) to provide to other software modules/routines. The SF module, which runs at a rate of 0.52 Hz (2 sec/cycle), determines the selected data to be used by navigation software. This selection is accomplished by monitoring commfaults, lock-on status, BITE flag status, crew select/deselect status, and comparison of data values between the MLS units. The DG Flag is set TRUE if the MLS units are available for processing or considered candidates.

#### **3.9.1 Three-Level SF**

Selected output data is midvalue selected from the three available units. In this case, the DG flag is set to a true state to notify Nav that good data is available to be processed. If one of the MLS units starts putting out data outside the RM limits, mid-value selection protects against its use by Nav until the unit is downmoded by FDIR.

#### **3.9.2 Two-Level SF**

At the two-level, the selected data is the average of the data from two available units. The RM limit test performed in FDIR is also performed in the SF to determine whether the units disagree. If the difference between the two units exceeds the RM limits for only one count, the DG flag is set to FALSE so that the data will not be used. Meanwhile, FDIR continues to attempt to isolate the failure. The rationale for immediately setting the DG flag to FALSE is to avoid averaging bad data. If the miscompare goes away with subsequent data, the DG flag is set to TRUE again, and MLS data is once again used.

If the miscompare is in elevation, elevation data is not used. If the miscompare is in range or azimuth, no MLS data is used. Nav resumes using TACAN and air data

information again (if above 1500 feet). Ratios/residuals for TACANs and air data reappears on SPEC 50 when their data is being used. The yellow “MLS” indication disappears.

### 3.9.3 One- and Zero-Level SF

At the one-level, the only data available is selected and the DG flag is set TRUE automatically. When there are no MLS units available, the DG flag is set FALSE and no new data is sent to Nav.

### 3.10 FAULT DETECTION, IDENTIFICATION, AND RECONFIGURATION

The MLS FDIR function detects errors and faults in the azimuth, elevation, and range data and determines which MLS unit(s), if any, should be declared failed. Declaring a parameter failed results in fault annunciation and FDIR downmoding of that MLS unit.

The FDIR function uses the same commfault, lock-on, and BITE status as in the SF module to determine the available MLS units. The DG flag status determines which MLS units are available for processing or considered candidates. A parameter is temporarily withheld from FDIR, but not declared failed, for loss of lock or commfault.

Based on availability, the absolute data difference between units is compared against an RM tolerance or limit. The RM limits for azimuth, elevation, and range are listed in [Table 3-2](#).

**Table 3-2. MLS FDIR RM limits**

| Maximum<br>MLS<br>parameter<br>differences | Azimuth | Elevation | Range                    |
|--|---------|-----------|--------------------------|
|  | 0.5°    | 0.4°      | 2000 ft<br>(0.329 n.mi.) |

#### 3.10.1 Three-Level FDIR

For the case of three MLS candidates, a parameter is declared failed if it is the common Parameter (P) in two miscomparisons for three consecutive FDIR cycles.

$$(P1 - P2) > k, (P1 - P3) > k, (P2 - P3) > k, \text{ where } k \text{ is the RM limit}$$

That MLS unit is then removed from further processing. At an FDIR rate of 0.25 Hz (approx. 4 sec/cycle), three consecutive miscompares take 12 seconds. Downmoding causes a down arrow to be displayed on GNC SYS SUMM 1, an “RM FAIL MLS” fault message to appear on all active PASS DPS displays, and an SM alert light and alarm tone to be generated.

Note: After an MLS unit has been downmoded by FDIR, it cannot be upmoded.

### 3.10.2 Two-Level FDIR

When one MLS unit has been downmoded, an MLS limit comparison is made by FDIR between the two remaining units. If RM is exceeded, the presence of BITE is checked to resolve the dilemma. If the BITE indication is present for an MLS, that MLS unit is declared failed. The FDIR is downmoded to the case of one good MLS. If no BITE or a BITE on both MLS units is present, the disagreement is annunciated. FDIR continues in dilemma until the crew solves the dilemma. In the dilemma case, two dilemma markers “?” are displayed on GNC SYS SUMM 1, an “RM DLMA MLS” fault message appears on all active PASS DPS displays, and an SM alert light and alarm tone are generated.

Note: After an MLS unit has been downmoded by FDIR, it cannot be upmoded.

The HSI is the only place where MLS data can be displayed for the crew to use to solve MLS dilemmas. However, there are several tricks that can be used to help identify which parameter is in the dilemma. After MLS locks on, the MLS data must pass the limit checks listed below before it is considered valid data.

- a. Shuttle heading with respect to selected runway centerline must be within  $\pm 55^\circ$  to satisfy elevation and azimuth requirements.
- b.  $0.5 < \text{elevation} < 29^\circ$ .
- c. Azimuth  $< \pm 13.5^\circ$  of runway centerline.
- d. Range  $< 5$  n.mi.

Therefore, range is considered valid anytime it is less than 15 n.mi. Azimuth and elevation are considered valid only when the orbiter heading is within  $55^\circ$  of the runway. As the orbiter goes around the Heading Alignment Cone (HAC), range data is considered valid. But azimuth and elevation are not because the orbiter is outside  $55^\circ$  with respect to the runway centerline. If a dilemma is annunciated while going around the HAC, it will be a range dilemma.

When MLS range and azimuth data are valid, the residuals and ratios for both TACANs and air data vanish and a yellow “MLS” indication appears on SPEC 50. If an MLS dilemma is annunciated and the TACAN and air data residuals/ratios remain blank and the “MLS” indication remains, the dilemma is an elevation dilemma because range and azimuth data are still valid. Range and azimuth parameters are required for MLS to be processed. Elevation is not required. More will follow on this subject under MLS Usage in Navigation section.

The last trick: As the orbiter flies around the HAC, the TACAN residuals/ratios should eventually blank and the “MLS” indicator should appear as the orbiter heading with respect to the runway centerline becomes less than  $55^\circ$ , allowing the azimuth and elevation to become valid. Remember that both azimuth and range must be valid for Nav to process MLS. If an MLS dilemma is annunciated while the orbiter heading is

within  $55^\circ$ . If the TACAN residuals/ratios remain and no "MLS" indication is displayed, it is most likely an azimuth dilemma. The TACAN residuals and ratios never go away because either range or azimuth is not valid. The best guess is that it is an azimuth dilemma because the orbiter went around the HAC without a dilemma. The last conclusion rests on the assumption that any MLS range problem would have happened long before rounding the HAC. If the problem occurs after the HAC, this could be either a range or an azimuth dilemma. See summary below.

- a. Dilemma while orbiter heading  $> 55^\circ$  with respect to runway (i.e., going around the HAC) is range dilemma.
- b. Dilemma after MLS locks on, but TACAN residuals and ratios remain blank and "MLS" indicator remains, is an elevation dilemma.
- c. Dilemma while orbiter heading is  $< 55^\circ$  with respect to runway, but TACAN residuals and ratios remain and no "MLS" indicator appears, is most likely an azimuth dilemma. There is a small possibility it could be a range dilemma.

### **3.10.3 One- and Zero-Level FDIR**

No FDIR exists at the one- and zero-level.

## **3.11 MICROWAVE LANDING SYSTEM USAGE IN NAVIGATION**

During approach and landing, Nav uses MLS data to estimate the orbiter position and velocity (the state vector) relative to the runway. The crew must dial up the MLS channel number corresponding to the selected runway for the proper MLS data to be supplied to Nav. MLS channel selection is not downlinked on telemetry. So ground controllers cannot tell if the wrong channel is selected. If a runway is selected that does not have MLS, Nav sets the MLS AVAIL flag to OFF, which inhibits Nav processing of any MLS data that may be received from another runway.

When MLS azimuth and range are acquired, Nav stops processing TACAN and air data and begins processing MLS in addition to IMU data in order to update the state vector. Elevation data is incorporated into Nav if valid. Elevation data is not necessary for azimuth and range data to be used. However, neither azimuth nor range data is incorporated into Nav without the other. To use MLS data, Nav must see a DG flag set true for azimuth and a DG flag set true for range for at least one unit.

PASS GNC SYS SUMM is monitored by the crew for MLS lock-on status and GNC SPEC 50 for navigation incorporation. When the "M's" on PASS GNC SYS SUMM 1 blank next to the MLS status, both azimuth and range MLS data have locked on. Nav stops processing TACAN and air data and begins processing MLS data. This is indicated by the residuals and ratios becoming blank and the "MLS" indicator appearing on PASS GNC SPEC 50. If TACAN data is being FORCED on PASS GNC SPEC 50, MLS data will never get incorporated into Nav.

Preland navigation is automatically initialized when entry navigation first receives a "Data Good" flag from MLS RM. After preland navigation is initiated, it continues through touchdown and rollout even if the MLS data drops out. In preland navigation, only one state vector is propagated as compared to three state vectors (one for each IMU) in entry navigation. There are two reasons for downmoding to one state vector. First, since accurate information is very important near the ground, preland navigation cycles once every 1.92 sec as compared to once every 3.84 sec for entry navigation. With the shorter cycle time, fewer calculations can be performed in preland navigation. Second, and more significantly, the MLS data is much more accurate than any of the sensor data available in entry navigation. The safety factor of having a state vector from each IMU to minimize errors due to an IMU failure is not needed. Nav will revert back to processing TACAN and air data if MLS data is lost above 1500 feet for more than 6 seconds. If MLS has been processed and is lost below 1500 feet, Nav will not revert back to TACAN or air data. Air data will be used only above 500 feet to prevent transients at low altitudes if MLS is never processed.

### **3.12 LAUNCH COMMIT CRITERIA REQUIREMENTS**

Two of three MLSs are required for launch if both RAs are good. However, three of three MLS units are required if one RA is failed.

### **3.13 BFS DIFFERENCES**

BFS does not support MLS.

## **QUESTIONS: MICROWAVE LANDING SYSTEM**

1. When is MLS data used?
2. What parameters does MLS provide?
3. List the two channels that have been cleared for orbiter landing operations.
4. MLS is processed by BFS and PASS. True or False?
5. MLS FDIR processes in OPS 3 and 6 for PASS. True or False?
6. What are MLS RM limits?
7. Which two parameters are needed to process MLS?
8. What is preland navigation?

**ANSWERS: MICROWAVE LANDING SYSTEM**

1. MLS is used upon switchover from TACANS and air data at an altitude of approximately 18,000 feet.
2.
  - a) Azimuth angle.
  - b) Elevation angle.
  - c) Slant range.
3. Channels 6 and 8.
4. False. BFS does not use MLS.
5. True.
6. 

|     |   |         |
|-----|---|---------|
| AZ  | - | 0.5°    |
| EL  | - | 0.4°    |
| RNG | - | 2000 ft |
7. AZ and RNG are needed. EL is optional and used if available.
8. Preland navigation is automatically initialized when entry navigation first receives a "Data Good" flag from MLS RM. Only one state vector is propagated as compared to three state vectors (one for each IMU) in entry navigation.

## 4.0 RADAR ALTIMETER

### 4.1 INTRODUCTION

The orbiter uses two RAs, which operate concurrently. The RA is a low-altitude terrain-tracking radar system. Accurate tracking is maintained at altitudes between 0 and 5000 feet. The RA can measure absolute altitude to the nearest terrain and can track altitude rate changes up to 2000 ft/s. The RA is used only for displaying altitude data on the MEDS Flight Instrument display and the HUD.

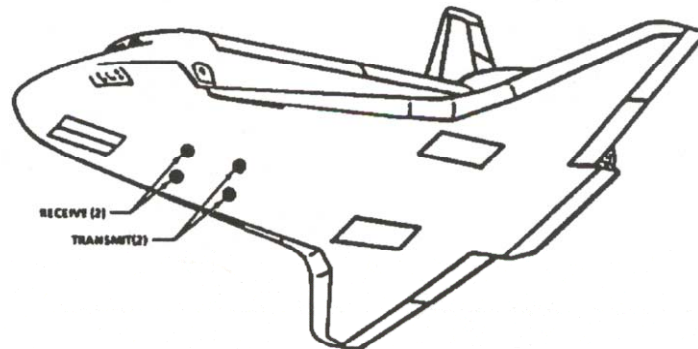
### 4.2 PERFORMANCE OBJECTIVES

As a result of studying this section, the student should be able to do the following:

- a. Explain when RAs are available
- b. Describe whether RA data is fed to Nav
- c. Explain what is required to establish RA communications
- d. Identify which RA BFS will use

### 4.3 RADAR ALTIMETER OPERATION

Each radar altimeter has two antennas (one transmitting and one receiving). The antennas are located on the underside of the orbiter nose (*Figure 4-1*). The antenna beam width is a 40° cone about the orbiter Z-axis.



**Figure 4-1. RA antenna location**



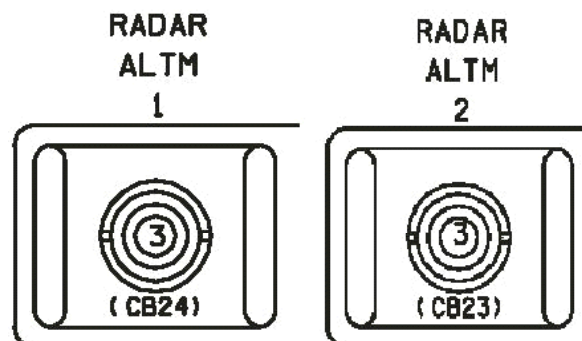
Altitude information is derived from tracking the reflected ground pulse. Altitude signals are proportional to the elapsed time required for a pulse to return from the ground. The returning pulse is a function of height or distance from the nearest terrain. The RAs remain locked onto the return pulse during altitude change rates up to 2000 feet per second. This allows tracking of mountain or cliff sides ahead of or adjacent to the vehicle if these obstacles are nearer than the ground below and provides warning of rapid changes in absolute altitude.

RA 1 is connected to FF MDM 1 and RA 2 to FF MDM 2. Within the MDM is a special IOM or "card" that is dedicated to RAs and TACANs (this scheme was implemented to accommodate off-the-shelf TACAN and RA equipment). If this module fails, a BCE STRG X TAC fault message is annunciated. This failure inhibits TACAN and RA data inputs from that MDM to the GPCs.

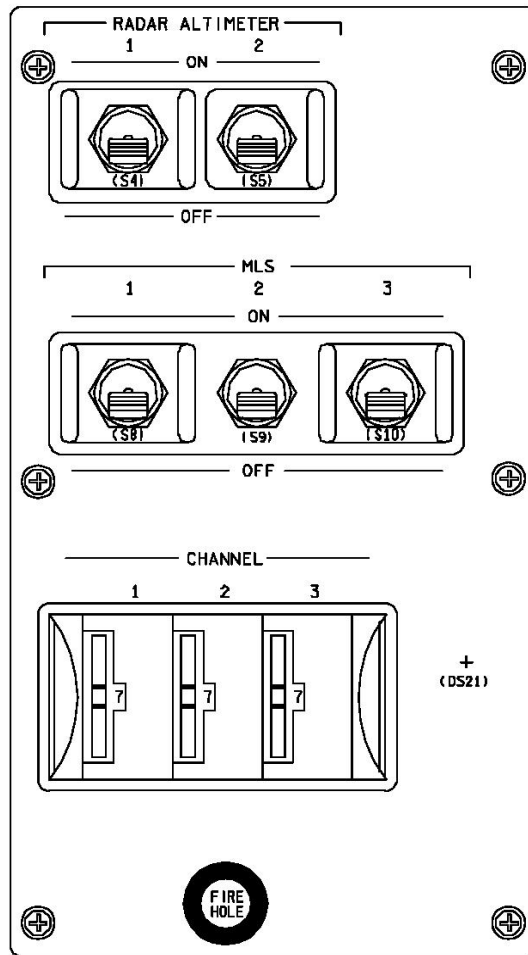
Note: A useful point to remember is that no I/O RESET is needed when these units are powered ON because the TACAN and RA are attached to this special IOM.

#### 4.4 RADAR ALTIMETER CREW CONTROLS

The RA requires 28 Volt direct current (V dc), which is controlled by circuit breakers on Panels O14 and O15 and by power ON/OFF switches located on Panel O8 ([Figure 4-2](#) and [Figure 4-3](#)). Both RAs are powered ON for ascent and entry. An I/O RESET is not required to establish communication with the RAs or TACANs after they are powered ON.

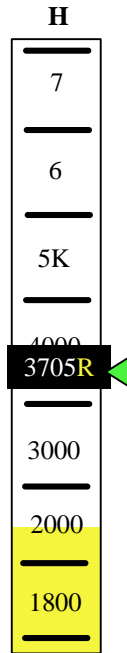


**Figure 4-2. RA circuit breakers on Panels O14 and O15**

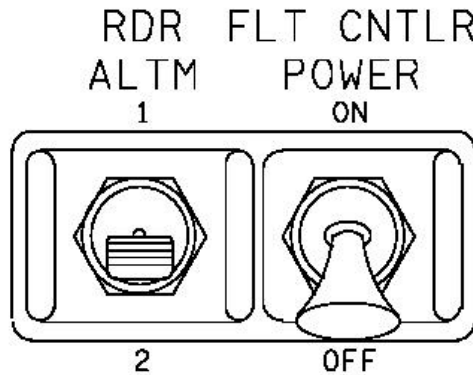


**Figure 4-3. RA power switches on Panel O8**

The RA select switches are located on Panel F6 and F8. These switches allow the crew to select which RA (RA 1 or RA 2) is to be displayed on the CDR or PLT's MEDS Flight Instrument display (see [Figure 4-4](#) and [Figure 4-5](#)) or the HUD. When the RAs lock on at 5000 feet, it is important for the crew to evaluate them to detect any altitude bias. One method used is to flip the RA switch from 1 to 2 and watch for the tapes to jump. If they jump, one RA is biased. To determine which RA is biased, they can be compared to Nav-selected altitude by selecting Nav on the Air Data switch on Panel F6/F8. The radar altitude is displayed in conjunction with the navigation-derived altitude when an "R" is displayed in the digital readout box. The radar altitude value is displayed in the digital readout box and indicated by a green triangle that will move along the altitude tape. The navigation-derived altitude is not clearly visible. You can conclude it to be the altitude that is indicated behind the digital readout box. The scale of the RA tape changes during the entry profile starting at 2000 ft. Because of this scale change, it is harder to see small RA altitude biases at higher altitudes, while below 2000 feet they seem significant. Normally, the CDR selects RA 1 and the PLT selects RA 2.



**Figure 4-4. RA tape**



**Figure 4-5. RA tape select switches on Panels F6 and F8**

If FF 1 fails, several LRUs connected to FF 1 are also bypassed, including RA 1. An FF 1 failure also fails the CDR's flight instrument display switches to their green dot positions. Green dot means the instrument switches are assumed by the GPCs to be in one particular position. Small green dots are placed next to these positions. When a crewmember is green dot, the crewmember procedurally will move their switches to these positions (although this is not required for the GPCs to assume the positions of these switches). Since an FF 1 failure takes out RA 1 and makes the CDR green dot, the green dot position for the RA switch for the CDR is RA 2. The PLT green dot position is RA 1 (opposite the normal position). Pilot is green dot if FF2 MDM fails.

## 4.5 RADAR ALTIMETER DPS DISPLAYS

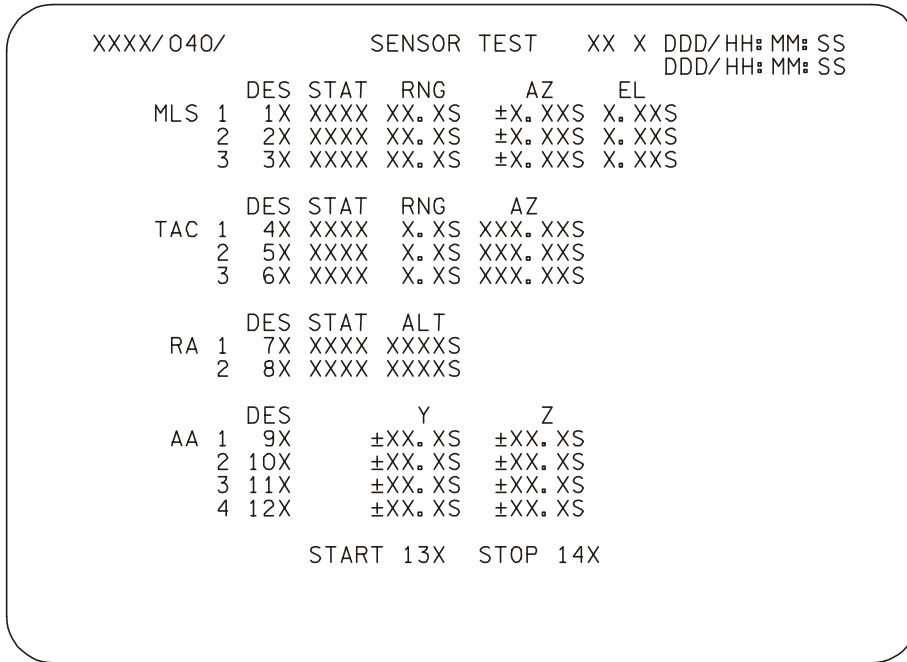
RA information is displayed on two DPS displays: Sensor Test in OPS 8 and Sensor Self-Test in OPS 9.

### 4.5.1 SPEC 40 - Sensor Test Display

The Sensor Test display (*Figure 4-6*) is available in OPS 8 and can be called up through SPEC 40 PRO for the on-orbit FCS Checkout. SPEC 40 provides a means of initiating, monitoring, and terminating the self-test of the RA. Altimeter (ALT) in feet is displayed for each RA. These values are compared to the self-test limits. A status indicator is displayed next to the ALT parameter indicating the result of the tolerance check. Execution of Item 13 begins the self-test on all the displayed sensors. Execution of Item 14 stops the self-test. An "\*" appears next to Items 13 or 14 to indicate, respectively, that tests are underway or tests are stopped. Items 13 and 14 are initialized blank.

SPEC 40 also provides control of the SF. Execution of a DES item number changes the RA as a candidate for the SF. An "\*" appears next to the item number if the corresponding unit is deselected as a candidate. The SF configuration from this display is carried over into OPS 3. Once the crew deselects a RA, it cannot be selected to provide valid data for display on the MEDS flight instrument display or HUD.

Note: The BFS is not informed of sensors deselected on SPEC 40. Therefore, it is important to turn these units OFF.



006055008. CRT# 1

Test limits are as follows:

Alt 1000 ± 100 ft

**Figure 4-6. On-orbit Sensor Test**

#### 4.5.2 SPEC 101 - Sensor Self-Test Display

The Sensor Self-Test display is available in OPS 9 through SPEC 101 PRO for preflight and postlanding checkout of the RA and other sensors ([Figure 4-7](#)). It is the ground test equivalent of the on-orbit Sensor Test (SPEC 40).

```

XXXX/101/      SENSOR SELF-TEST      XX X DDD/HH: MM: SS
                                     DDD/HH: MM: SS

  ENA STAT  RNG   AZ    EL
M1  1X XXXX XX.XS ±X.XXS X.XXS
L2  2X XXXX XX.XS ±X.XXS X.XXS
S3  3X XXXX XX.XS ±X.XXS X.XXS

  ENA STAT  RNG   AZ
T1  4X XXXX X.XS XXX.XXS
A2  5X XXXX X.XS XXX.XXS
C3  6X XXXX X.XS XXX.XXS

  ENA STAT  ALT
R1  7X XXXX XXXXS
A2  8X XXXX XXXXS

  ENA          Y      Z
A1  9X      ±XX.XS ±XX.XS
A2 10X      ±XX.XS ±XX.XS
  3 11X      ±XX.XS ±XX.XS
  4 12X      ±XX.XS ±XX.XS

TEST CONTROL:
START      13X
AUTO SEQ   14X
TERM       15X

INH ALL 16X

```

006055006. CRT# 1

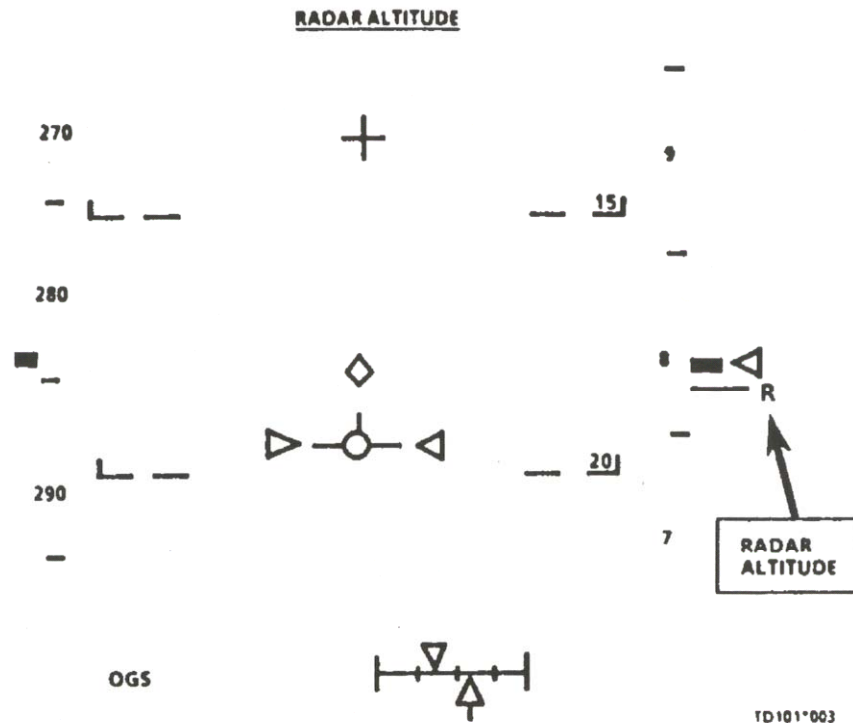
**Figure 4-7. Sensor Self-Test**

#### 4.6 RADAR ALTIMETER SOFTWARE

The RA software provides the data needed to drive the MEDS Flight Instrument Display and HUD. See [Figure 4-8](#). This software provides the crew with the orbiter altitude in feet (from the orbiter rear wheels to the runway) with the altitude validity and lock-on indications.

All RA software processing is performed at 6.25-Hz rate (0.16 sec/cycle). It is dispatched by the ascent, RTLS, and entry major modes. However, even though the software is working onboard, the only times MCC receives RA telemetry are during OPS 8, OPS 6, and OPS 3.

Raw altitude data is processed as long as the RA is locked on, not commfaulted, and not deselected by the crew. Crew deselection can be accomplished only in OPS 8, but will carry across OPS transitions.



**Figure 4-8. HUD display with radar altimeter**

The RA software does not contain any FDIR logic. The RA data, even though it is not used by Nav, does go through an SF. The SF determines the status and usability of the data depending on the data available. RA data is currently bypassed by the Autoland software and used for display purposes only.

The BFS processes RA for display only on the MEDS Flight Instrument display during MM 603 and MM 305. In a BFS engage situation, the BFS dedicated display processor outputs the RA (the RA that has the first valid lock-on) altitude to both the CDR and PLT's Flight Instrument display. BFS does not read RA select switch positions. The BFS will switch between the two RAs in an attempt to obtain one with a valid lock-on. For BFS to use the RA, it needs to have a valid lock-on and not be commfaulted. Therefore, if RA 1 locks on late, the BFS would be using RA 2. If RA 1 is the first to lock on and it is biased, the only way to display RA 2 is to commfault RA 1. To do so, the RA 1 power switch can be placed to the OFF position. There is no RA telemetry data from the BFS.

#### **4.7 LAUNCH COMMIT CRITERIA REQUIREMENTS**

One of two RAs is required for launch. However, two of two RA units are required if one MLS is failed or a night landing is planned.

#### **4.8 BFS DIFFERENCES**

1. BFS does not read RA switch positions. The RA that has the first valid lock-on is displayed for both the CDR's and PLT's Flight Instrument Display.
2. BFS does not support OPS 8 Sensor Test and OPS 9 Sensor Self-Test displays. BFS is not informed of sensors (RAs) deselected on SPEC 40 (Sensor Test) in OPS 8. Therefore, it is important to turn these units off.



## **QUESTIONS: RADAR ALTIMETER**

1. When is RA used?
2. RA data is fed to Nav to update SV. True or False?
3. RA requires no I/O RESET when these units are powered ON. True or False?
4. BFS uses RA 1 for display purposes only. True or False?

**ANSWERS: RADAR ALTIMETER**

1. Accurate tracking is maintained at altitudes between 0 and 5000 feet.
2. False – Display purpose only.
3. True – Because the TACAN and RA are attached to this special IOM.
4. False – BFS uses the first RA that locks on. RA 1 and 2 switches are not supported in BFS.

## APPENDIX A      ACRONYMS AND ABBREVIATIONS

|         |  |
|---------|--|
| A/E PFD | Ascent/Entry Primary Flight Display                  |
| ADS     | Air Data System                                      |
| ADTA    | Air Data Transducer Assembly                         |
| AGC     | Automatic Gain Control                               |
| AIF     | Auto, Inhibit, and Force                             |
| ALT     | Altitude   |
| ANT SEL | Antenna Select                                       |
| AUT     | Auto   |
| AUTO    | Automatic  |
| AZ      | Azimuth  |
|         |  |
| BFS     | Backup Flight System                                 |
| BIT     | Built-In Test  |
| BITE    | Built-In-Test Equipment                              |
| BRG     | Bearing  |
|         |  |
| C&W     | Caution and Warning                                  |
| cb      | circuit breaker                                      |
| CDI     | Course Deviation Indicator                           |
| CDR     | Commander  |
| COMM    | Communications                                       |
| cps     | cycles per second                                    |
|         |  |
| dc      | direct current                                       |
| DG FAIL | Data Good Fail                                       |
| DLMA    | Dilemma  |
| DME     | Distance Measurement Equipment                       |
| DPS     | Data Processing System                               |
| DTO     | Detailed Test Objective                              |
|         |  |
| EL      | Elevation  |
| EOM     | End of Mission                                       |
|         |  |
| FC      | Flight Critical                                      |
| FD      | Fault Detection                                      |
| FDIR    | Fault Detection, Identification, and Reconfiguration |
| FF      | Flight Forward                                       |
| FI      | Fault Identification                                 |
| FOM     | Figure of Merit                                      |
| FOR     | Force  |
| FR      | Fault Reconfiguration                                |
|         |  |
| G&C     | Guidance and Control                                 |
| GDOP    | Geometric Dilution of Precision                      |
| GHz     | Gigahertz  |

|            |   |
|------------|---|
| GLS        | Ground Launch Sequencer                       |
| GNC        | Guidance, Navigation, and Control             |
| GPC        | General Purpose Computer                      |
| GPS        | Global Positioning System                     |
| GRTLS      | Glide Return to Landing/Launch Site           |
| GS         | Ground Station                                |
|            |   |
| HAC        | Heading Alignment Circle                      |
| HSD        | Horizontal Situation Display                  |
| HSI        | Horizontal Situation Indicator                |
| HUD        | Heads-Up Display                              |
| Hz         | Hertz   |
|            |   |
| I/O        | Input/Output                                  |
| IPL        | Initial Program Load                          |
| IMU        | Inertial Measurement Unit                     |
| INH        | Inhibit                                       |
| INS        | Inertial Navigation System                    |
| IOM        | Input/Output Module                           |
|            |   |
| Kft        | Thousands of feet                             |
|            |   |
| LAT        | Latitude                                      |
| LON        | Longitude                                     |
| LRU        | Line Replaceable Unit                         |
|            |   |
| MCC        | Mission Control Center                        |
| MDM        | Multiplexer/Demultiplexer                     |
| MEDS       | Multifunction Electronic Display System       |
| MLS        | Microwave Landing System                      |
| MLS-GS     | MLS Ground Station                            |
| MLS-NS     | MLS Navigation Set                            |
| MM         | Major Mode                                    |
| MVS        | Midvalue Select                               |
|            |   |
| NASA       | National Aeronautics and Space Administration |
| Nav or NAV | Navigation                                    |
| n.mi.      | nautical mile                                 |
| NS         | Navigation Set                                |
|            |   |
| OI         | Operational Instrumentation                   |
| OPS        | Operational Sequence<br>Operations            |
|            |   |
| P          | Parameter                                     |
| PASS       | Primary Avionics Software System              |
| PCM        | Pulse Code Modulation                         |
| PLT        | Pilot   |

|                  |  |
|------------------|--|
| PNL              | Panel  |
| POB              | Power-On Built-in  |
| PVA              | Position, Velocity, Acceleration   |
| QA               | Quality Assessment   |
| RA               | Radar Altimeter  |
| RATIO            | ratio  |
| RCV              | Receive  |
| RCVR             | Receiver   |
| RESID            | Residual   |
| RF               | Radio Frequency  |
| RM               | Redundancy Management  |
| RNG              | Range  |
| rps              | revolutions per second   |
| RSLs             | Redundant Set Launch Sequencer   |
| RTLS             | Return-to-Launch Site  |
| SF               | Selection Filter   |
| SFOC             | Space Flight Operations Contract   |
| SOP              | Subsystem Operating Plan   |
| SYS SUMM         | System Summary   |
| T/R              | Transmit/Receive   |
| TAC/RA IOM       | TACAN/Radar Altimeter Input/Output Module                                    |
| TACAN            | Tactical Air Command and Navigation System                                   |
| TAEM             | Terminal Area Energy Management  |
| TSM              | Test Status Monitor  |
| UPP              | User Parameter Processing  |
| USA              | United Space Alliance  |
| UVW              | Local Vertical quasi-inertial coordinate system with components<br>U, V, & W |
| V                | Volt   |
| V <sub>rel</sub> | Relative Velocity  |